

# $\mu$ A7800 Series 3-Terminal Positive Voltage Regulators

Linear Products

### Description

The  $\mu$ A7800 series of monolithic 3-Terminal Positive Voltage Regulators is constructed using the Fairchild Planar epitaxial process. These regulators employ internal current-limiting, thermal-shutdown and safe-area compensation, making them essentially indestructible. If adequate heat sinking is provided, they can deliver over 1 A output current. They are intended as fixed voltage regulators in a wide range of applications including local (on card) regulation for elimination of distribution problems associated with single point regulation. In addition to use as fixed voltage regulators, these devices can be used with external components to obtain adjustable output voltages and currents.

- **OUTPUT CURRENT IN EXCESS OF 1 A**
- **NO EXTERNAL COMPONENTS**
- **INTERNAL THERMAL OVERLOAD PROTECTION**
- **INTERNAL SHORT CIRCUIT CURRENT LIMITING**
- **OUTPUT TRANSISTOR SAFE-AREA COMPENSATION**
- **AVAILABLE IN THE TO-220 AND THE TO-3 PACKAGE**
- **OUTPUT VOLTAGES OF 5, 6, 8, 8.5, 12, 15, 18, AND 24 V**

### Absolute Maximum Ratings

Input Voltage (5 V through 18 V)	35 V
(24 V)	40 V
Internal Power Dissipation	Internally Limited
Storage Temperature Range	-65°C to +150°C
Operating Junction Temperature Range	
$\mu$ A7800	-55°C to +150°C
$\mu$ A7800C	0°C to +125°C
Pin Temperature	
Soldering, 60s time limit	
TO-3 Package	300°C
Soldering, 10s time limit	
TO-220 Package	230°C

### Connection Diagram TO-3 Package

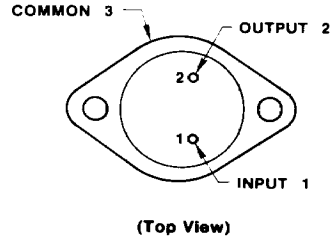

### Order Information

Type	Package	Code	Part No.
$\mu$ A7805	Metal	HJ	$\mu$ A7805KM
$\mu$ A7806	Metal	HJ	$\mu$ A7806KM
$\mu$ A7808	Metal	HJ	$\mu$ A7808KM
$\mu$ A7812	Metal	HJ	$\mu$ A7812KM
$\mu$ A7815	Metal	HJ	$\mu$ A7815KM
$\mu$ A7818	Metal	HJ	$\mu$ A7818KM
$\mu$ A7824	Metal	HJ	$\mu$ A7824KM
$\mu$ A7805C	Metal	HJ	$\mu$ A7805KC
$\mu$ A7806C	Metal	HJ	$\mu$ A7806KC
$\mu$ A7808C	Metal	HJ	$\mu$ A7808KC
$\mu$ A7812C	Metal	HJ	$\mu$ A7812KC
$\mu$ A7815C	Metal	HJ	$\mu$ A7815KC
$\mu$ A7818C	Metal	HJ	$\mu$ A7818KC
$\mu$ A7824C	Metal	HJ	$\mu$ A7824KC

### Connection Diagram To-220 Package

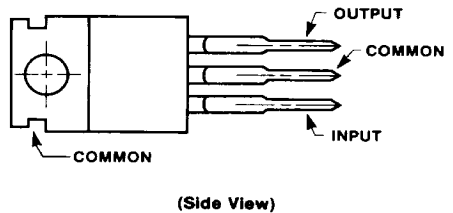

### Order Information

Type	Package	Code	Part No.
$\mu$ A7805C	Molded Power Pack	GH	$\mu$ A7805UC
$\mu$ A7806C	Molded Power Pack	GH	$\mu$ A7806UC
$\mu$ A7808C	Molded Power Pack	GH	$\mu$ A7808UC
$\mu$ A7885C	Molded Power Pack	GH	$\mu$ A7885UC
$\mu$ A7812C	Molded Power Pack	GH	$\mu$ A7812UC
$\mu$ A7815C	Molded Power Pack	GH	$\mu$ A7815UC
$\mu$ A7818C	Molded Power Pack	GH	$\mu$ A7818UC
$\mu$ A7824C	Molded Power Pack	GH	$\mu$ A7824UC

Equivalent Circuit

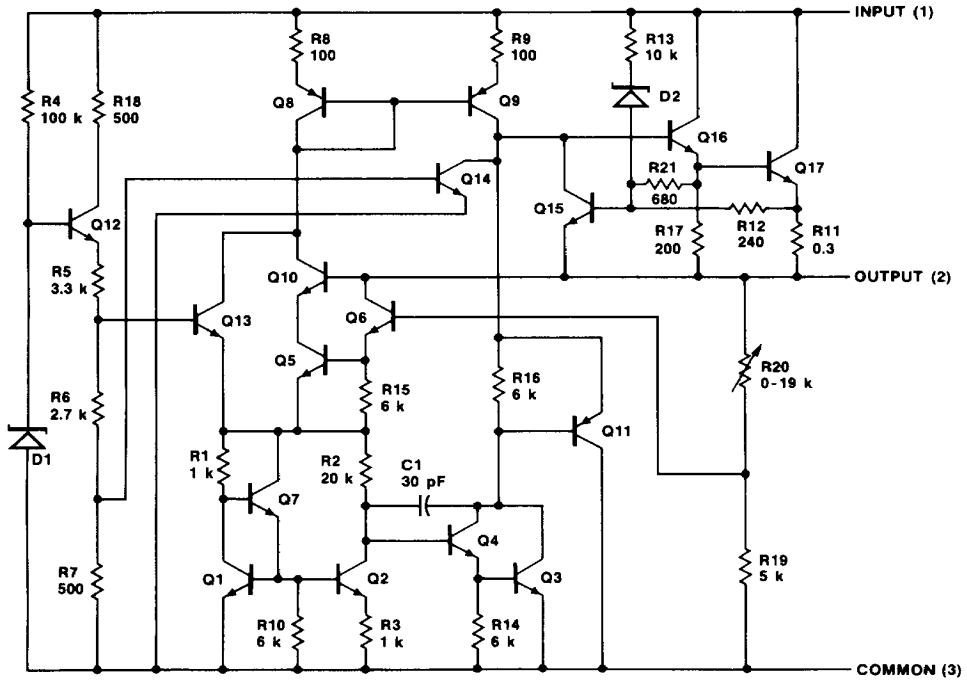

2

## μA7800 Series

### μA7805

**Electrical Characteristics**  $V_{IN} = 10\text{ V}$ ,  $I_{OUT} = 500\text{ mA}$ ,  $-55^{\circ}\text{C} \leq T_J \leq 150^{\circ}\text{C}$ ,  $C_{IN} = 0.33\text{ }\mu\text{F}$ ,  $C_{OUT} = 0.1\text{ }\mu\text{F}$ , unless otherwise specified.

Characteristic	Condition (Note)	Min	Typ	Max	Unit	
Output Voltage	$T_J = 25^{\circ}\text{C}$	4.8	5.0	5.2	V	
Line Regulation	$T_J = 25^{\circ}\text{C}$	$7\text{ V} \leq V_{IN} \leq 25\text{ V}$		3	50	mV
		$8\text{ V} \leq V_{IN} \leq 12\text{ V}$		1	25	mV
Load Regulation	$T_J = 25^{\circ}\text{C}$	$5\text{ mA} \leq I_{OUT} \leq 1.5\text{ A}$		15	100	mV
		$250\text{ mA} \leq I_{OUT} \leq 750\text{ mA}$		5	25	mV
Output Voltage	$8.0\text{ V} \leq V_{IN} \leq 20\text{ V}$ $5\text{ mA} \leq I_{OUT} \leq 1.0\text{ A}$ $P \leq 15\text{ W}$	4.65		5.35	V	
Quiescent Current	$T_J = 25^{\circ}\text{C}$		4.2	6.0	mA	
Quiescent Current Change	with line	$8\text{ V} \leq V_{IN} \leq 25\text{ V}$		0.8	mA	
	with load	$5\text{ mA} \leq I_{OUT} \leq 1.0\text{ A}$		0.5	mA	
Output Noise Voltage	$T_A = 25^{\circ}\text{C}$ , $10\text{ Hz} \leq f \leq 100\text{ kHz}$		8	40	$\mu\text{V}/V_{OUT}$	
Ripple Rejection	$f = 120\text{ Hz}$ , $8\text{ V} \leq V_{IN} \leq 18\text{ V}$	68	78		dB	
Dropout Voltage	$I_{OUT} = 1.0\text{ A}$ , $T_J = 25^{\circ}\text{C}$		2.0	2.5	V	
Output Resistance	$f = 1\text{ kHz}$		17		m $\Omega$	
Short-Circuit Current	$T_J = 25^{\circ}\text{C}$ , $V_{IN} = 35\text{ V}$		0.75	1.2	A	
Peak Output Current	$T_J = 25^{\circ}\text{C}$	1.3	2.2	3.3	A	
Average Temperature Coefficient of Output Voltage	$I_{OUT} = 5\text{ mA}$	$-55^{\circ}\text{C} \leq T_J \leq +25^{\circ}\text{C}$		0.4	$\text{mV}/^{\circ}\text{C}/V_{OUT}$	
		$+25^{\circ}\text{C} \leq T_J \leq +150^{\circ}\text{C}$		0.3	$V_{OUT}$	

### μA7805C

**Electrical Characteristics**  $V_{IN} = 10\text{ V}$ ,  $I_{OUT} = 500\text{ mA}$ ,  $0^{\circ}\text{C} \leq T_J \leq 125^{\circ}\text{C}$ ,  $C_{IN} = 0.33\text{ }\mu\text{F}$ ,  $C_{OUT} = 0.1\text{ }\mu\text{F}$ , unless otherwise specified.

Characteristic	Condition (Note)	Min	Typ	Max	Unit	
Output Voltage	$T_J = 25^{\circ}\text{C}$	4.8	5.0	5.2	V	
Line Regulation	$T_J = 25^{\circ}\text{C}$	$7\text{ V} \leq V_{IN} \leq 25\text{ V}$		3	100	mV
		$8\text{ V} \leq V_{IN} \leq 12\text{ V}$		1	50	mV
Load Regulation	$T_J = 25^{\circ}\text{C}$	$5\text{ mA} \leq I_{OUT} \leq 1.5\text{ A}$		15	100	mV
		$250\text{ mA} \leq I_{OUT} \leq 750\text{ mA}$		5	50	mV
Output Voltage	$7\text{ V} \leq V_{IN} \leq 20\text{ V}$ $5\text{ mA} \leq I_{OUT} \leq 1.0\text{ A}$ $P \leq 15\text{ W}$	4.75		5.25	V	
Quiescent Current	$T_J = 25^{\circ}\text{C}$		4.2	8.0	mA	
Quiescent Current Change	with line	$7\text{ V} \leq V_{IN} \leq 25\text{ V}$		1.3	mA	
	with load	$5\text{ mA} \leq I_{OUT} \leq 1.0\text{ A}$		0.5	mA	
Output Noise Voltage	$T_A = 25^{\circ}\text{C}$ , $10\text{ Hz} \leq f \leq 100\text{ kHz}$		40		$\mu\text{V}$	
Ripple Rejection	$f = 120\text{ Hz}$ , $8\text{ V} \leq V_{IN} \leq 18\text{ V}$	62	78		dB	
Dropout Voltage	$I_{OUT} = 1.0\text{ A}$ , $T_J = 25^{\circ}\text{C}$		2.0		V	
Output Resistance	$f = 1\text{ kHz}$		17		m $\Omega$	
Short-Circuit Current	$T_J = 25^{\circ}\text{C}$ , $V_{IN} = 35\text{ V}$		750		mA	
Peak Output Current	$T_J = 25^{\circ}\text{C}$		2.2		A	
Average Temperature Coefficient of Output Voltage	$I_{OUT} = 5\text{ mA}$ , $0^{\circ}\text{C} \leq T_J \leq 125^{\circ}\text{C}$		1.1		$\text{mV}/^{\circ}\text{C}$	

## μA7800 Series

### μA7806C

**Electrical Characteristics**  $V_{IN} = 11\text{ V}$ ,  $I_{OUT} = 500\text{ mA}$ ,  $0^{\circ}\text{C} \leq T_J \leq 125^{\circ}\text{C}$ ,  $C_{IN} = 0.33\text{ }\mu\text{F}$ ,  $C_{OUT} = 0.1\text{ }\mu\text{F}$ , unless otherwise specified.

Characteristic	Condition (Note)	Min	Typ	Max	Unit	
Output Voltage	$T_J = 25^{\circ}\text{C}$	5.75	6.0	6.25	V	
Line Regulation	$T_J = 25^{\circ}\text{C}$	$8\text{ V} \leq V_{IN} \leq 25\text{ V}$		5	120	mV
		$9\text{ V} \leq V_{IN} \leq 13\text{ V}$		1.5	60	mV
Load Regulation	$T_J = 25^{\circ}\text{C}$	$5\text{ mA} \leq I_{OUT} \leq 1.5\text{ A}$		14	120	mV
		$250\text{ mA} \leq I_{OUT} \leq 750\text{ mA}$		4	60	mV
Output Voltage	$8\text{ V} \leq V_{IN} \leq 21\text{ V}$ $5\text{ mA} \leq I_{OUT} \leq 1.0\text{ A}$ $P \leq 15\text{ W}$	5.7		6.3	V	
Quiescent Current	$T_J = 25^{\circ}\text{C}$		4.3	8.0	mA	
Quiescent Current Change	with line	$8\text{ V} \leq V_{IN} \leq 25\text{ V}$			1.3	mA
	with load	$5\text{ mA} \leq I_{OUT} \leq 1.0\text{ A}$			0.5	mA
Output Noise Voltage	$T_A = 25^{\circ}\text{C}$ , $10\text{ Hz} \leq f \leq 100\text{ kHz}$		45		$\mu\text{V}$	
Ripple Rejection	$f = 120\text{ Hz}$ , $9\text{ V} \leq V_{IN} \leq 19\text{ V}$	59	75		dB	
Dropout Voltage	$I_{OUT} = 1.0\text{ A}$ , $T_J = 25^{\circ}\text{C}$		2.0		V	
Output Resistance	$f = 1\text{ kHz}$		19		$\text{m}\Omega$	
Short-Circuit Current	$T_J = 25^{\circ}\text{C}$ , $V_{IN} = 35\text{ V}$		550		mA	
Peak Output Current	$T_J = 25^{\circ}\text{C}$		2.2		A	
Average Temperature Coefficient of Output Voltage	$I_{OUT} = 5\text{ mA}$ , $0^{\circ}\text{C} \leq T_J \leq 125^{\circ}\text{C}$		0.8		$\text{mV}/^{\circ}\text{C}$	

2

#### Note

- For all tables, all characteristics except noise voltage and ripple rejection ratio are measured using pulse techniques ( $t_w \leq 10\text{ ms}$ , duty cycle  $\leq 5\%$ ). Output voltage changes due to changes in internal temperature must be taken into account separately.

## μA7800 Series

### μA7808

**Electrical Characteristics**  $V_{IN} = 14\text{ V}$ ,  $I_{OUT} = 500\text{ mA}$ ,  $-55^{\circ}\text{C} \leq T_J \leq 150^{\circ}\text{C}$ ,  $C_{IN} = 0.33\text{ }\mu\text{F}$ ,  $C_{OUT} = 0.1\text{ }\mu\text{F}$ , unless otherwise specified.

Characteristic	Condition (Note)		Min	Typ	Max	Unit
Output Voltage	$T_J = 25^{\circ}\text{C}$		7.7	8.0	8.3	V
Line Regulation	$T_J = 25^{\circ}\text{C}$	$10.5\text{ V} \leq V_{IN} \leq 25\text{ V}$		6.0	80	mV
		$11\text{ V} \leq V_{IN} \leq 17\text{ V}$		2.0	40	mV
Load Regulation	$T_J = 25^{\circ}\text{C}$	$5\text{ mA} \leq I_{OUT} \leq 1.5\text{ A}$		12	100	mV
		$250\text{ mA} \leq I_{OUT} \leq 750\text{ mA}$		4.0	40	mV
Output Voltage	$11.5\text{ V} \leq V_{IN} \leq 23\text{ V}$ $5\text{ mA} \leq I_{OUT} \leq 1.0\text{ A}$ $P \leq 15\text{ W}$		7.6		8.4	V
Quiescent Current	$T_J = 25^{\circ}\text{C}$			4.3	6.0	mA
Quiescent Current Change	with line	$11.5\text{ V} \leq V_{IN} \leq 25\text{ V}$			0.8	mA
	with load	$5\text{ mA} \leq I_{OUT} \leq 1.0\text{ A}$			0.5	mA
Output Noise Voltage	$T_A = 25^{\circ}\text{C}$ , $10\text{ Hz} \leq f \leq 100\text{ kHz}$			8	40	$\mu\text{V}/V_{OUT}$
Ripple Rejection	$f = 120\text{ Hz}$ , $11.5\text{ V} \leq V_{IN} \leq 21.5\text{ V}$		62	72		dB
Dropout Voltage	$I_{OUT} = 1.0\text{ A}$ , $T_J = 25^{\circ}\text{C}$			2.0	2.5	V
Output Resistance	$f = 1\text{ kHz}$			16		$\text{m}\Omega$
Short-Circuit Current	$T_J = 25^{\circ}\text{C}$ , $V_{IN} = 35\text{ V}$			0.75	1.2	A
Peak Output Current	$T_J = 25^{\circ}\text{C}$		1.3	2.2	3.3	A
Average Temperature Coefficient of Output Voltage	$I_{OUT} = 5\text{ mA}$	$-55^{\circ}\text{C} \leq T_J \leq +25^{\circ}\text{C}$			0.4	$\text{mV}/^{\circ}\text{C}/V_{OUT}$
		$+25^{\circ}\text{C} \leq T_J \leq 150^{\circ}\text{C}$			0.3	$V_{OUT}$

### μA7808C

**Electrical Characteristics**  $V_{IN} = 14\text{ V}$ ,  $I_{OUT} = 500\text{ mA}$ ,  $0^{\circ}\text{C} \leq T_J \leq 125^{\circ}\text{C}$ ,  $C_{IN} = 0.33\text{ }\mu\text{F}$ ,  $C_{OUT} = 0.1\text{ }\mu\text{F}$ , unless otherwise specified.

Characteristic	Condition (Note)		Min	Typ	Max	Unit
Output Voltage	$T_J = 25^{\circ}\text{C}$		7.7	8.0	8.3	V
Line Regulation	$T_J = 25^{\circ}\text{C}$	$10.5\text{ V} \leq V_{IN} \leq 25\text{ V}$		6.0	160	mV
		$11\text{ V} \leq V_{IN} \leq 17\text{ V}$		2.0	80	mV
Load Regulation	$T_J = 25^{\circ}\text{C}$	$5\text{ mA} \leq I_{OUT} \leq 1.5\text{ A}$		12	160	mV
		$250\text{ mA} \leq I_{OUT} \leq 750\text{ mA}$		4.0	80	mV
Output Voltage	$10.5\text{ V} \leq V_{IN} \leq 23\text{ V}$ $5\text{ mA} \leq I_{OUT} \leq 1.0\text{ A}$ $P \leq 15\text{ W}$		7.6		8.4	V
Quiescent Current	$T_J = 25^{\circ}\text{C}$			4.3	8.0	mA
Quiescent Current Change	with line	$10.5\text{ V} \leq V_{IN} \leq 25\text{ V}$			1.0	mA
	with load	$5\text{ mA} \leq I_{OUT} \leq 1.0\text{ A}$			0.5	mA
Output Noise Voltage	$T_A = 25^{\circ}\text{C}$ , $10\text{ Hz} \leq f \leq 100\text{ kHz}$			52		$\mu\text{V}$
Ripple Rejection	$f = 120\text{ Hz}$ , $11.5\text{ V} \leq V_{IN} \leq 21.5\text{ V}$		56	72		dB
Dropout Voltage	$I_{OUT} = 1.0\text{ A}$ , $T_J = 25^{\circ}\text{C}$			2.0		V
Output Resistance	$f = 1\text{ kHz}$			16		$\text{m}\Omega$
Short-Circuit Current	$T_J = 25^{\circ}\text{C}$ , $V_{IN} = 35\text{ V}$			450		mA
Peak Output Current	$T_J = 25^{\circ}\text{C}$			2.2		A
Average Temperature Coefficient of Output Voltage	$I_{OUT} = 5\text{ mA}$ , $0^{\circ}\text{C} \leq T_J \leq 125^{\circ}\text{C}$			0.8		$\text{mV}/^{\circ}\text{C}$

**μA7885C**

**Electrical Characteristics**  $V_{IN} = 15\text{ V}$ ,  $I_{OUT} = 500\text{ mA}$ ,  $-55^{\circ}\text{C} \leq T_J \leq 150^{\circ}\text{C}$ ,  $C_{IN} = 0.33\ \mu\text{F}$ ,  $C_{OUT} = 0.1\ \mu\text{F}$ , unless otherwise specified.

Characteristic	Condition (Note)	Min	Typ	Max	Unit	
Output Voltage	$T_J = 25^{\circ}\text{C}$	8.15	8.5	8.85	V	
Line Regulation	$T_J = 25^{\circ}\text{C}$	$10.5\text{ V} \leq V_{IN} \leq 25\text{ V}$		6.0	170	mV
		$11\text{ V} \leq V_{IN} \leq 17\text{ V}$		2.0	85	mV
Load Regulation	$T_J = 25^{\circ}\text{C}$	$5\text{ mA} \leq I_{OUT} \leq 1.5\text{ A}$		12	170	mV
		$250\text{ mA} \leq I_{OUT} \leq 750\text{ mA}$		4.0	85	mV
Output Voltage	$11\text{ V} \leq V_{IN} \leq 23.5\text{ V}$ $5\text{ mA} \leq I_{OUT} \leq 1.0\text{ A}$ $P \leq 15\text{ W}$	8.1		8.9	V	
Quiescent Current	$T_J = 25^{\circ}\text{C}$		4.3	8.0	mA	
Quiescent Current Change	with line	$10.5\text{ V} \leq V_{IN} \leq 25\text{ V}$		1.0	mA	
	with load	$5\text{ mA} \leq I_{OUT} \leq 1.0\text{ A}$		0.5	mA	
Output Noise Voltage	$T_A = 25^{\circ}\text{C}$ , $10\text{ Hz} \leq f \leq 100\text{ kHz}$		55		μV	
Ripple Rejection	$f = 120\text{ Hz}$ , $11.5\text{ V} \leq V_{IN} \leq 21.5\text{ V}$	56	70		dB	
Dropout Voltage	$I_{OUT} = 1.0\text{ A}$ , $T_J = 25^{\circ}\text{C}$		2.0		V	
Output Resistance	$f = 1\text{ kHz}$		16		mΩ	
Short-Circuit Current	$T_J = 25^{\circ}\text{C}$ , $V_{IN} = 35\text{ V}$		450		mA	
Peak Output Current	$T_J = 25^{\circ}\text{C}$		2.2		A	
Average Temperature Coefficient of Output Voltage	$I_{OUT} = 5\text{ mA}$ , $0^{\circ}\text{C} \leq T_J \leq 125^{\circ}\text{C}$		0.8		mV/°C	

2

**Note**

- For all tables, all characteristics except noise voltage and ripple rejection ratio are measured using pulse techniques ( $t_W \leq 10\text{ ms}$ , duty cycle  $\leq 5\%$ ). Output voltage changes due to changes in internal temperature must be taken into account separately.

## μA7800 Series

### μA7812

**Electrical Characteristics**  $V_{IN} = 19\text{ V}$ ,  $I_{OUT} = 500\text{ mA}$ ,  $-55^{\circ}\text{C} \leq T_J \leq 150^{\circ}\text{C}$ ,  $C_{IN} = 0.33\text{ }\mu\text{F}$ ,  $C_{OUT} = 0.1\text{ }\mu\text{F}$ , unless otherwise specified.

Characteristic	Condition (Note)		Min	Typ	Max	Unit
Output Voltage	$T_J = 25^{\circ}\text{C}$		11.5	12.0	12.5	V
Line Regulation	$T_J = 25^{\circ}\text{C}$	$14.5\text{ V} \leq V_{IN} \leq 30\text{ V}$		10	120	mV
		$16\text{ V} \leq V_{IN} \leq 22\text{ V}$		3.0	60	mV
Load Regulation	$T_J = 25^{\circ}\text{C}$	$5\text{ mA} \leq I_{OUT} \leq 1.5\text{ A}$		12	120	mV
		$250\text{ mA} \leq I_{OUT} \leq 750\text{ mA}$		4.0	60	mV
Output Voltage	$15.5\text{ V} \leq V_{IN} \leq 27\text{ V}$ $5\text{ mA} \leq I_{OUT} \leq 1.0\text{ A}$ $P \leq 15\text{ W}$		11.4		12.6	V
Quiescent Current	$T_J = 25^{\circ}\text{C}$			4.3	6.0	mA
Quiescent Current Change	with line	$15\text{ V} \leq V_{IN} \leq 30\text{ V}$			0.8	mA
	with load	$5\text{ mA} \leq I_{OUT} \leq 1.0\text{ A}$			0.5	mA
Output Noise Voltage	$T_A = 25^{\circ}\text{C}$ , $10\text{ Hz} \leq f \leq 100\text{ kHz}$			8	40	$\mu\text{V}/V_{OUT}$
Ripple Rejection	$f = 120\text{ Hz}$ , $15\text{ V} \leq V_{IN} \leq 25\text{ V}$		61	71		dB
Dropout Voltage	$I_{OUT} = 1.0\text{ A}$ , $T_J = 25^{\circ}\text{C}$			2.0	2.5	V
Output Resistance	$f = 1\text{ kHz}$			18		m $\Omega$
Short-Circuit Current	$T_J = 25^{\circ}\text{C}$ , $V_{IN} = 35\text{ V}$			0.75	1.2	A
Peak Output Current	$T_J = 25^{\circ}\text{C}$		1.3	2.2	3.3	A
Average Temperature Coefficient of Output Voltage	$I_{OUT} = 5\text{ mA}$	$-55^{\circ}\text{C} \leq T_J \leq +25^{\circ}\text{C}$			0.4	mV/ $^{\circ}\text{C}/V_{OUT}$
		$+25^{\circ}\text{C} \leq T_J \leq 150^{\circ}\text{C}$			0.3	

### μA7812C

**Electrical Characteristics**  $V_{IN} = 19\text{ V}$ ,  $I_{OUT} = 500\text{ mA}$ ,  $0^{\circ}\text{C} \leq T_J \leq 125^{\circ}\text{C}$ ,  $C_{IN} = 0.33\text{ }\mu\text{F}$ ,  $C_{OUT} = 0.1\text{ }\mu\text{F}$ , unless otherwise specified.

Characteristic	Condition (Note)		Min	Typ	Max	Unit
Output Voltage	$T_J = 25^{\circ}\text{C}$		11.5	12.0	12.5	V
Line Regulation	$T_J = 25^{\circ}\text{C}$	$14.5\text{ V} \leq V_{IN} \leq 30\text{ V}$		10	240	mV
		$16\text{ V} \leq V_{IN} \leq 22\text{ V}$		3.0	120	mV
Load Regulation	$T_J = 25^{\circ}\text{C}$	$5\text{ mA} \leq I_{OUT} \leq 1.5\text{ A}$		12	240	mV
		$250\text{ mA} \leq I_{OUT} \leq 750\text{ mA}$		4.0	120	mV
Output Voltage	$14.5\text{ V} \leq V_{IN} \leq 27\text{ V}$ $5\text{ mA} \leq I_{OUT} \leq 1.0\text{ A}$ $P \leq 15\text{ W}$		11.4		12.6	V
Quiescent Current	$T_J = 25^{\circ}\text{C}$			4.3	8.0	mA
Quiescent Current Change	with line	$14.5\text{ V} \leq V_{IN} \leq 30\text{ V}$			1.0	mA
	with load	$5\text{ mA} \leq I_{OUT} \leq 1.0\text{ A}$			0.5	mA
Output Noise Voltage	$T_A = 25^{\circ}\text{C}$ , $10\text{ Hz} \leq f \leq 100\text{ kHz}$			75		$\mu\text{V}$
Ripple Rejection	$f = 120\text{ Hz}$ , $15\text{ V} \leq V_{IN} \leq 25\text{ V}$		55	71		dB
Dropout Voltage	$I_{OUT} = 1.0\text{ A}$ , $T_J = 25^{\circ}\text{C}$			2.0		V
Output Resistance	$f = 1\text{ kHz}$			18		m $\Omega$
Short-Circuit Current	$T_J = 25^{\circ}\text{C}$ , $V_{IN} = 35\text{ V}$			350		mA
Peak Output Current	$T_J = 25^{\circ}\text{C}$			2.2		A
Average Temperature Coefficient of Output Voltage	$I_{OUT} = 5\text{ mA}$ , $0^{\circ}\text{C} \leq T_J \leq 125^{\circ}\text{C}$			1.0		mV/ $^{\circ}\text{C}$

## μA7800 Series

### μA7815

**Electrical Characteristics**  $V_{IN} = 23\text{ V}$ ,  $I_{OUT} = 500\text{ mA}$ ,  $-55^{\circ}\text{C} \leq T_J \leq 150^{\circ}\text{C}$ ,  $C_{IN} = 0.33\ \mu\text{F}$ ,  $C_{OUT} = 0.1\ \mu\text{F}$ , unless otherwise specified

Characteristic	Condition (Note)		Min	Typ	Max	Unit
Output Voltage	$T_J = 25^{\circ}\text{C}$		14.4	15.0	15.6	V
Line Regulation	$T_J = 25^{\circ}\text{C}$	$17.5\text{ V} \leq V_{IN} \leq 30\text{ V}$		11	150	mV
		$20\text{ V} \leq V_{IN} \leq 26\text{ V}$		3	75	mV
Load Regulation	$T_J = 25^{\circ}\text{C}$	$5\text{ mA} \leq I_{OUT} \leq 1.5\text{ A}$		12	150	mV
		$250\text{ mA} \leq I_{OUT} \leq 750\text{ mA}$		4	75	mV
Output Voltage	$18.5\text{ V} \leq V_{IN} \leq 30\text{ V}$ $5\text{ mA} \leq I_{OUT} \leq 1.0\text{ A}$ $P \leq 15\text{ W}$		14.25		15.75	V
Quiescent Current	$T_J = 25^{\circ}\text{C}$			4.4	6.0	mA
Quiescent Current Change	with line	$18.5\text{ V} \leq V_{IN} \leq 30\text{ V}$			0.8	mA
	with load	$5\text{ mA} \leq I_{OUT} \leq 1.0\text{ A}$			0.5	mA
Output Noise Voltage	$T_A = 25^{\circ}\text{C}$ , $10\text{ Hz} \leq f \leq 100\text{ kHz}$			8	40	$\mu\text{V}/V_{OUT}$
Ripple Rejection	$f = 120\text{ Hz}$ , $18.5\text{ V} \leq V_{IN} \leq 28.5\text{ V}$		60	70		dB
Dropout Voltage	$I_{OUT} = 1.0\text{ A}$ , $T_J = 25^{\circ}\text{C}$			2.0	2.5	V
Output Resistance	$f = 1\text{ kHz}$			19		$\text{m}\Omega$
Short-Circuit Current	$T_J = 25^{\circ}\text{C}$ , $V_{IN} = 35\text{ V}$			0.75		A
Peak Output Current	$T_J = 25^{\circ}\text{C}$		1.3	2.2	3.3	A
Average Temperature Coefficient of Output Voltage	$I_{OUT} = 5\text{ mA}$	$-55^{\circ}\text{C} \leq T_J \leq +25^{\circ}\text{C}$			0.4	$\text{mV}/^{\circ}\text{C}/V_{OUT}$
		$+25^{\circ}\text{C} \leq T_J \leq +150^{\circ}\text{C}$			0.3	$V_{OUT}$

### μA7815C

**Electrical Characteristics**  $V_{IN} = 23\text{ V}$ ,  $I_{OUT} = 500\text{ mA}$ ,  $0^{\circ}\text{C} \leq T_J \leq 125^{\circ}\text{C}$ ,  $C_{IN} = 0.33\ \mu\text{F}$ ,  $C_{OUT} = 0.1\ \mu\text{F}$ , unless otherwise specified.

Characteristic	Condition (Note)		Min	Typ	Max	Unit
Output Voltage	$T_J = 25^{\circ}\text{C}$		14.4	15.0	15.6	V
Line Regulation	$T_J = 25^{\circ}\text{C}$	$17.5\text{ V} \leq V_{IN} \leq 30\text{ V}$		11	300	mV
		$20\text{ V} \leq V_{IN} \leq 26\text{ V}$		3	150	mV
Load Regulation	$T_J = 25^{\circ}\text{C}$	$5\text{ mA} \leq I_{OUT} \leq 1.5\text{ A}$		12	300	mV
		$250\text{ mA} \leq I_{OUT} \leq 750\text{ mA}$		4	150	mV
Output Voltage	$17.5\text{ V} \leq V_{IN} \leq 30\text{ V}$ $5\text{ mA} \leq I_{OUT} \leq 1.0\text{ A}$ $P \leq 15\text{ W}$		14.25		15.75	V
Quiescent Current	$T_J = 25^{\circ}\text{C}$			4.4	8.0	mA
Quiescent Current Change	with line	$17.5\text{ V} \leq V_{IN} \leq 30\text{ V}$			1.0	mA
	with load	$5\text{ mA} \leq I_{OUT} \leq 1.0\text{ A}$			0.5	mA
Output Noise Voltage	$T_A = 25^{\circ}\text{C}$ , $10\text{ Hz} \leq f \leq 100\text{ kHz}$			90		$\mu\text{V}$
Ripple Rejection	$f = 120\text{ Hz}$ , $18.5\text{ V} \leq V_{IN} \leq 28.5\text{ V}$		54	70		dB
Dropout Voltage	$I_{OUT} = 1.0\text{ A}$ , $T_J = 25^{\circ}\text{C}$			2.0		V
Output Resistance	$f = 1\text{ kHz}$			19		$\text{m}\Omega$
Short-Circuit Current	$T_J = 25^{\circ}\text{C}$ , $V_{IN} = 35\text{ V}$			230		A
Peak Output Current	$T_J = 25^{\circ}\text{C}$			2.1		A
Average Temperature Coefficient of Output Voltage	$I_{OUT} = 5\text{ mA}$ , $0^{\circ}\text{C} \leq T_J \leq 125^{\circ}\text{C}$			1.0		$\text{mV}/^{\circ}\text{C}$



## μA7800 Series

### μA7818

**Electrical Characteristics**  $V_{IN} = 27\text{ V}$ ,  $I_{OUT} = 500\text{ mA}$ ,  $-55^{\circ}\text{C} \leq T_J \leq 150^{\circ}\text{C}$ ,  $C_{IN} = 0.33\ \mu\text{F}$ ,  $C_{OUT} = 0.1\ \mu\text{F}$ , unless otherwise specified.

Characteristic	Condition (Note)	Min	Typ	Max	Unit	
Output Voltage	$T_J = 25^{\circ}\text{C}$	17.3	18.0	18.7	V	
Line Regulation	$T_J = 25^{\circ}\text{C}$	$21\text{ V} \leq V_{IN} \leq 33\text{ V}$		15	180	mV
		$24\text{ V} \leq V_{IN} \leq 30\text{ V}$		5.0	90	mV
Load Regulation	$T_J = 25^{\circ}\text{C}$	$5\text{ mA} \leq I_{OUT} \leq 1.5\text{ A}$		12	180	mV
		$250\text{ mA} \leq I_{OUT} \leq 750\text{ mA}$		4.0	90	mV
Output Voltage	$22\text{ V} \leq V_{IN} \leq 33\text{ V}$ $5\text{ mA} \leq I_{OUT} \leq 1.0\text{ A}$ $P \leq 15\text{ W}$	17.1		18.9	V	
Quiescent Current	$T_J = 25^{\circ}\text{C}$		4.5	6.0	mA	
Quiescent Current Change	with line	$22\text{ V} \leq V_{IN} \leq 33\text{ V}$		0.8	mA	
	with load	$5\text{ mA} \leq I_{OUT} \leq 1.0\text{ A}$		0.5	mA	
Output Noise Voltage	$T_A = 25^{\circ}\text{C}$ , $10\text{ Hz} \leq f \leq 100\text{ kHz}$		8	40	$\mu\text{V}/V_{OUT}$	
Ripple Rejection	$f = 120\text{ Hz}$ , $22\text{ V} \leq V_{IN} \leq 32\text{ V}$	59	69		dB	
Dropout Voltage	$I_{OUT} = 1.0\text{ A}$ , $T_J = 25^{\circ}\text{C}$		2.0		V	
Output Resistance	$f = 1\text{ kHz}$		22	2.5	$\text{m}\Omega$	
Short-Circuit Current	$T_J = 25^{\circ}\text{C}$ , $V_{IN} = 35\text{ V}$		0.75	1.2	A	
Peak Output Current	$T_J = 25^{\circ}\text{C}$	1.3	2.2	3.3	A	
Average Temperature Coefficient of Output Voltage	$I_{OUT} = 5\text{ mA}$	$+25^{\circ}\text{C} \leq T_J \leq +150^{\circ}\text{C}$		0.4	$\text{mV}/^{\circ}\text{C}/V_{OUT}$	
		$-55^{\circ}\text{C} \leq T_J \leq +25^{\circ}\text{C}$		0.3		

### μA7818C

**Electrical Characteristics**  $V_{IN} = 27\text{ V}$ ,  $I_{OUT} = 500\text{ mA}$ ,  $0^{\circ}\text{C} \leq T_J \leq 125^{\circ}\text{C}$ ,  $C_{IN} = 0.33\ \mu\text{F}$ ,  $C_{OUT} = 0.1\ \mu\text{F}$ , unless otherwise specified.

Characteristic	Condition (Note)	Min	Typ	Max	Unit	
Output Voltage	$T_J = 25^{\circ}\text{C}$	17.3	18.0	18.7	V	
Line Regulation	$T_J = 25^{\circ}\text{C}$	$21\text{ V} \leq V_{IN} \leq 33\text{ V}$		15	360	mV
		$24\text{ V} \leq V_{IN} \leq 30\text{ V}$		5.0	180	mV
Load Regulation	$T_J = 25^{\circ}\text{C}$	$5\text{ mA} \leq I_{OUT} \leq 1.5\text{ A}$		12	360	mV
		$250\text{ mA} \leq I_{OUT} \leq 750\text{ mA}$		4.0	180	mV
Output Voltage	$21\text{ V} \leq V_{IN} \leq 33\text{ V}$ $5\text{ mA} \leq I_{OUT} \leq 1.0\text{ A}$ $P \leq 15\text{ W}$	17.1		18.9	V	
Quiescent Current	$T_J = 25^{\circ}\text{C}$		4.5	8.0	mA	
Quiescent Current Change	with line	$21\text{ V} \leq V_{IN} \leq 33\text{ V}$		1.0	mA	
	with load	$5\text{ mA} \leq I_{OUT} \leq 1.0\text{ A}$		0.5	mA	
Output Noise Voltage	$T_A = 25^{\circ}\text{C}$ , $10\text{ Hz} \leq f \leq 100\text{ kHz}$		110		$\mu\text{V}$	
Ripple Rejection	$f = 120\text{ Hz}$ , $22\text{ V} \leq V_{IN} \leq 32\text{ V}$	53	69		dB	
Dropout Voltage	$I_{OUT} = 1.0\text{ A}$ , $T_J = 25^{\circ}\text{C}$		2.0		V	
Output Resistance	$f = 1\text{ kHz}$		22		$\text{m}\Omega$	
Short-Circuit Current	$T_J = 25^{\circ}\text{C}$ , $V_{IN} = 35\text{ V}$		200		mA	
Peak Output Current	$T_J = 25^{\circ}\text{C}$		2.1		A	
Average Temperature Coefficient of Output Voltage	$I_{OUT} = 5\text{ mA}$ , $0^{\circ}\text{C} \leq T_J \leq 125^{\circ}\text{C}$		1.0		$\text{mV}/^{\circ}\text{C}$	

## μA7800 Series

### μA7824

**Electrical Characteristics**  $V_{IN} = 33\text{ V}$ ,  $I_{OUT} = 500\text{ mA}$ ,  $-55^{\circ}\text{C} \leq T_J \leq 150^{\circ}\text{C}$ ,  $C_{IN} = 0.33\text{ }\mu\text{F}$ ,  $C_{OUT} = 0.1\text{ }\mu\text{F}$ , unless otherwise specified.

Characteristic	Condition (Note)		Min	Typ	Max	Unit
Output Voltage	$T_J = 25^{\circ}\text{C}$		23.0	24.0	25.0	V
Line Regulation	$T_J = 25^{\circ}\text{C}$	$27\text{ V} \leq V_{IN} \leq 38\text{ V}$		18	240	mV
		$30\text{ V} \leq V_{IN} \leq 36\text{ V}$		6	120	mV
Load Regulation	$T_J = 25^{\circ}\text{C}$	$5\text{ mA} \leq I_{OUT} \leq 1.5\text{ A}$		12	240	mV
		$250\text{ mA} \leq I_{OUT} \leq 750\text{ mA}$		4	120	mV
Output Voltage	$28\text{ V} \leq V_{IN} \leq 38\text{ V}$ $5\text{ mA} \leq I_{OUT} \leq 1.0\text{ A}$ $P \leq 15\text{ W}$		22.8		25.2	V
Quiescent Current	$T_J = 25^{\circ}\text{C}$			4.6	6.0	mA
Quiescent Current Change	with line	$28\text{ V} \leq V_{IN} \leq 38\text{ V}$			0.8	mA
	with load	$5\text{ mA} \leq I_{OUT} \leq 1.0\text{ A}$			0.5	mA
Output Noise Voltage	$T_A = 25^{\circ}\text{C}$ , $10\text{ Hz} \leq f \leq 100\text{ kHz}$			8	40	$\mu\text{V}/V_{OUT}$
Ripple Rejection	$f = 120\text{ Hz}$ , $28\text{ V} \leq V_{IN} \leq 38\text{ V}$		56	66		dB
Dropout Voltage	$I_{OUT} = 1.0\text{ A}$ , $T_J = 25^{\circ}\text{C}$			2.0	2.5	V
Output Resistance	$f = 1\text{ kHz}$			28		$\text{m}\Omega$
Short-Circuit Current	$T_J = 25^{\circ}\text{C}$ , $V_{IN} = 35\text{ V}$			0.75	1.2	A
Peak Output Current	$T_J = 25^{\circ}\text{C}$		1.3	2.2	3.3	A
Average Temperature Coefficient of Output Voltage	$I_{OUT} = 5\text{ mA}$	$-55^{\circ}\text{C} \leq T_J \leq +25^{\circ}\text{C}$			0.4	$\text{mV}/^{\circ}\text{C}/V_{OUT}$
		$+25^{\circ}\text{C} \leq T_J \leq +150^{\circ}\text{C}$			0.3	$V_{OUT}$

### μA7824C

**Electrical Characteristics**  $V_{IN} = 33\text{ V}$ ,  $I_{OUT} = 500\text{ mA}$ ,  $0^{\circ}\text{C} \leq T_J \leq 125^{\circ}\text{C}$ ,  $C_{IN} = 0.33\text{ }\mu\text{F}$ ,  $C_{OUT} = 0.1\text{ }\mu\text{F}$ , unless otherwise specified.

Characteristic	Condition (Note)		Min	Typ	Max	Unit
Output Voltage	$T_J = 25^{\circ}\text{C}$		23.0	24.0	25.0	V
Line Regulation	$T_J = 25^{\circ}\text{C}$	$27\text{ V} \leq V_{IN} \leq 38\text{ V}$		18	480	mV
		$30\text{ V} \leq V_{IN} \leq 36\text{ V}$		6	240	mV
Load Regulation	$T_J = 25^{\circ}\text{C}$	$5\text{ mA} \leq I_{OUT} \leq 1.5\text{ A}$		12	480	mV
		$250\text{ mA} \leq I_{OUT} \leq 750\text{ mA}$		4	240	mV
Output Voltage	$27\text{ V} \leq V_{IN} \leq 38\text{ V}$ $5\text{ mA} \leq I_{OUT} \leq 1.0\text{ A}$ $P \leq 15\text{ W}$		22.8		25.2	V
Quiescent Current	$T_J = 25^{\circ}\text{C}$			4.6	8.0	mA
Quiescent Current Change	with line	$27\text{ V} \leq V_{IN} \leq 38\text{ V}$			1.0	mA
	with load	$5\text{ mA} \leq I_{OUT} \leq 1.0\text{ A}$			0.5	mA
Output Noise Voltage	$T_A = 25^{\circ}\text{C}$ , $10\text{ Hz} \leq f \leq 100\text{ kHz}$			170		$\mu\text{V}$
Ripple Rejection	$f = 120\text{ Hz}$ , $28\text{ V} \leq V_{IN} \leq 38\text{ V}$		50	66		dB
Dropout Voltage	$I_{OUT} = 1.0\text{ A}$ , $T_J = 25^{\circ}\text{C}$			2.0		V
Output Resistance	$f = 1\text{ kHz}$			28		$\text{m}\Omega$
Short-Circuit Current	$T_J = 25^{\circ}\text{C}$ , $V_{IN} = 35\text{ V}$			150		mA
Peak Output Current	$T_J = 25^{\circ}\text{C}$			2.1		A
Average Temperature Coefficient of Output Voltage	$I_{OUT} = 5\text{ mA}$ , $0^{\circ}\text{C} \leq T_J \leq 125^{\circ}\text{C}$			1.5		$\text{mV}/^{\circ}\text{C}$

**Typical Performance Curves**

**Worst Case Power Dissipation Versus Ambient Temperature (TO-3)**

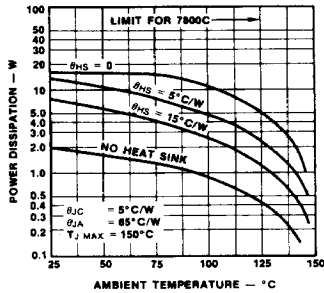

**Worst Case Power Dissipation Versus Ambient Temperature (TO-220)**

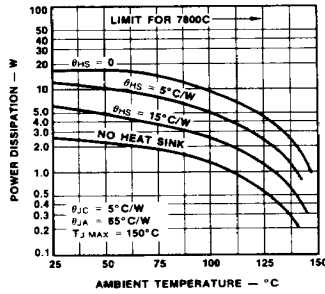

**Dropout Voltage as a Function of Junction Temperature**

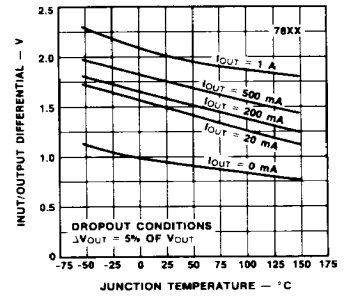

**Ripple Rejection as a Function of Frequency**

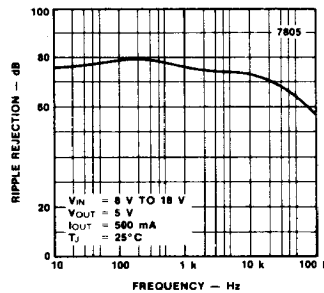

**Dropout Characteristics**

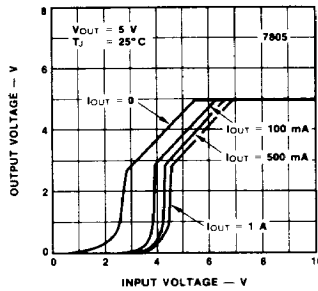

**Line Transient Response**

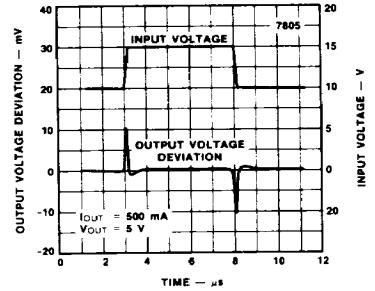

**Peak Output Current as a Function of Input/Output Differential Voltage**

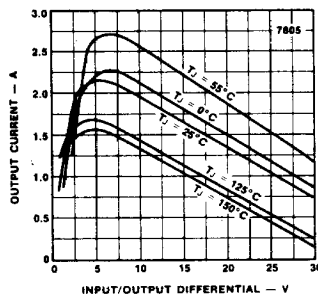

**Load Transient Response**

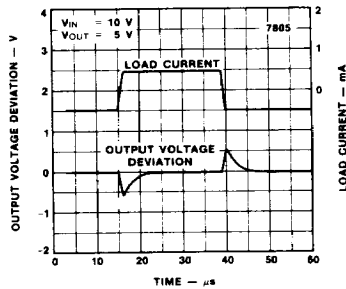

**Quiescent Current as a Function of Input Voltage**

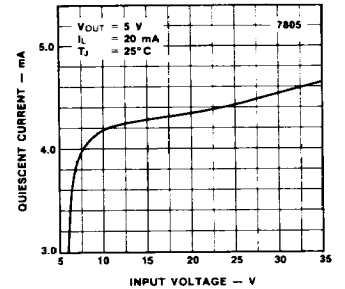

Typical Performance Curves (Cont.)

Output Voltage as a Function of Junction Temperature

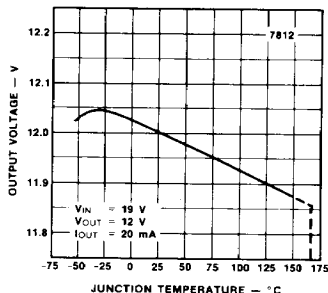

Current Limiting Characteristics

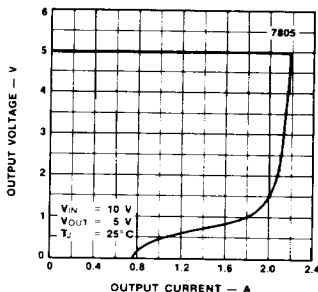

Output Impedance as a Function of Frequency

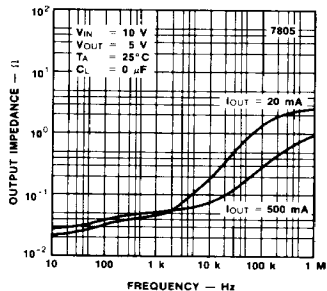

Quiescent Current as a Function of Temperature

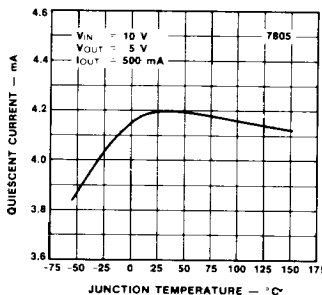

Note

The other μA7800 series devices have similar curves.

DC Parameter Test Circuit

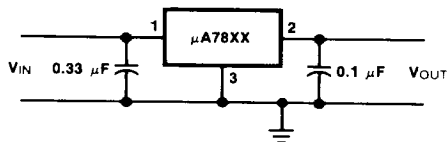

Design Considerations

The μA7800 fixed voltage regulator series has thermal-overload protection from excessive power dissipation, internal short circuit protection which limits the regulator's maximum current, and output transistor safe area-compensation for reducing the output current as the voltage across the pass transistor is increased.

Although the internal power dissipation is limited, the junction temperature must be kept below the maximum specified temperature (150°C for 7800, 125°C for 7800C) in order to meet data sheet specifications. To calculate the maximum junction temperature or heat sink required, the following thermal resistance values should be used:

Package	Typ	Max	Typ	Max
	$\theta_{JC}$	$\theta_{JC}$	$\theta_{JA}$	$\theta_{JA}$
	°C/W	°C/W	°C/W	°C/W
TO-3	3.5	5.5	40	45
TO-220	3.0	5.0	60	65

$$P_{D(MAX)} = \frac{T_{J(MAX)} - T_A}{\theta_{JC} + \theta_{CA}} \text{ or } \frac{T_{J(MAX)} - T_A}{\theta_{JA}}$$

(Without heat sink)

$$\theta_{CA} = \theta_{CS} + \theta_{SA}$$

solving for  $T_J$ :  $T_J = T_A + P_D (\theta_{JC} + \theta_{CA})$   
 or  $T_A + P_D \theta_{JA}$  (Without heat sink)

- where  $T_J$  = Junction Temperature  
 $T_A$  = Ambient Temperature  
 $P_D$  = Power Dissipation  
 $\theta_{JC}$  = Junction-to-case thermal resistance  
 $\theta_{CA}$  = Case-to-ambient thermal resistance  
 $\theta_{CS}$  = Case-to-heat sink to thermal resistance  
 $\theta_{SA}$  = Heat sink-to-ambient thermal resistance  
 $\theta_{JA}$  = Junction-to-ambient thermal resistance

## Typical Applications

### Fixed Output Regulator

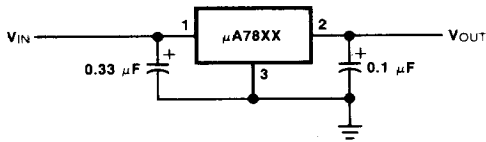

#### Notes

1. To specify an output voltage, substitute voltage value for "XX."
2. Bypass capacitors are recommended for optimum stability and transient response, and should be located as close as possible to the regulator.

### High Current Voltage Regulator

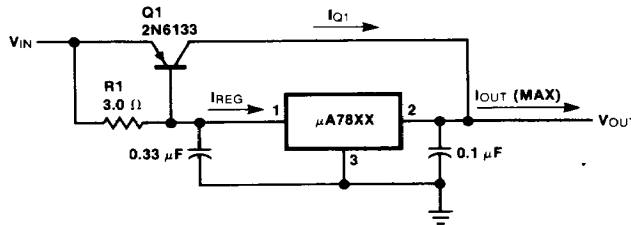

$$\beta(Q1) \geq \frac{I_{OUT(Max)}}{I_{REG(Max)}}$$

$$R1 = \frac{0.9}{I_{REG}} = \frac{\beta(Q1) V_{BE}(Q1)}{I_{REG(Max)} (\beta + 1) - I_{OUT(Max)}}$$

### Dual Supply

#### Operational Amplifier Supply ( $\pm 15\text{ V @ }1.0\text{ A}$ )

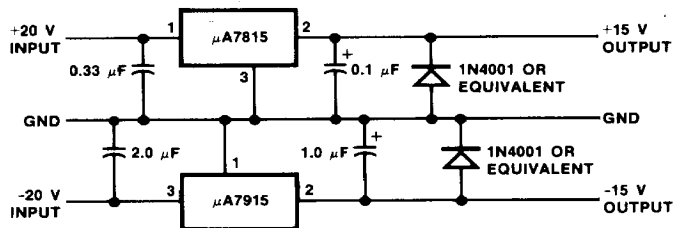

### High Input Voltage Circuits

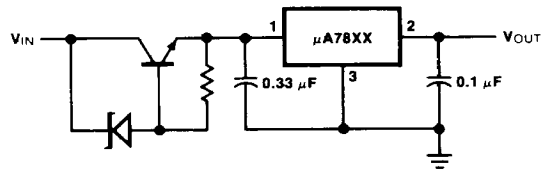
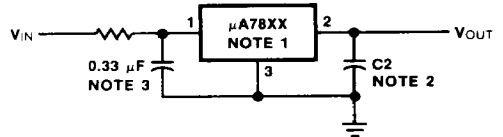

### Positive and Negative Regulator

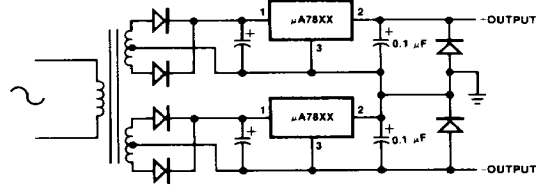

High Output Current,  
Short Circuit Protected

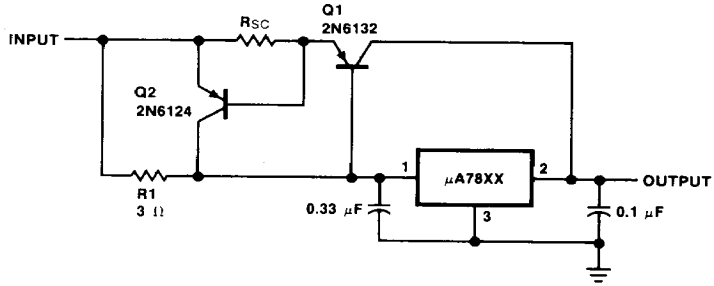

$$R_{SC} = \frac{0.8}{I_{SC}}$$
$$R_1 = \frac{\beta V_{BE}(Q_1)}{I_{REG}(\text{Max}) (\beta + 1) - I_{OUT}(\text{Max})}$$

Positive and Negative Regulator

