

FEATURES

- *Guaranteed 2%* Initial Tolerance of output voltage
- 5 Amp Output Current
- 40 Watt Capability
- Full Internal Overload Protection
- 100% Burn-in in Thermal Limit

APPLICATIONS

- Local 5V Regulators
- On Card Regulation
- Lab Supplies
- Instrumentation Supplies

DESCRIPTION

The LT1003 is a 5 amp version of the popular LM123 5V regulator. In addition to higher output current, it offers improved line regulation and an initial output voltage tolerance of $\pm 2\%$. These tightened specifications ease design and application problems several ways: safety margin is improved, error budgets on other parts of the system are expanded, and output voltage loss due to long supply runs can be better tolerated.

The LT1003 incorporates Linear Technology's advanced design, process and test techniques for improved quality and reliability over similar device types. Specifically, all devices are burned in by shorting the outputs, thereby forcing the regulator into its current limit and eventually, thermal limit mode. This ensures that all device protection features are working.

Standard 5 Volt Regulator

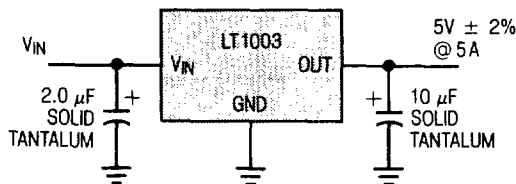

Load Regulation *

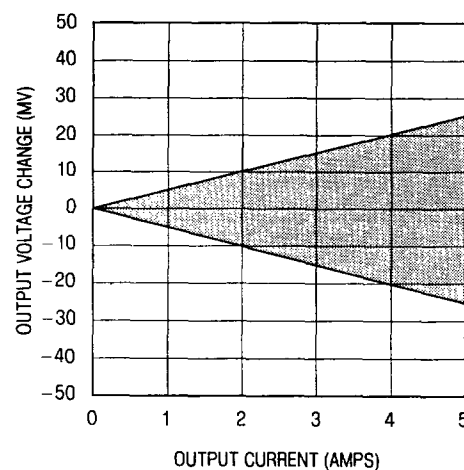

* The LT1003 has load compensation to cancel the effects of voltage loss in the output lead. This results in a nominal "zero" load regulation. The shaded band shows typical production spread.

ABSOLUTE MAXIMUM RATINGS

Input Voltage 20 Volts
 Power Dissipation Internally Limited
 Operating Junction Temperature Range
 LT1003M -55°C to 150°C
 LT1003C 0°C to 125°C
 Storage Temperature Range
 LT1003M -65°C to 150°C
 LT1003C -65°C to 150°C
 Lead Temperature (Soldering, 10 sec.) 300°C

PACKAGE/ORDER INFORMATION

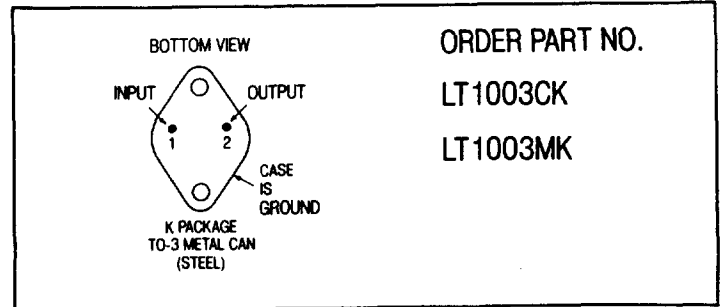

PRECONDITIONING

100% Burn-In in Thermal Limit

ELECTRICAL CHARACTERISTICS (See Note 1)

SYMBOL	PARAMETER	CONDITIONS	LT1003M			LT1003C			UNITS
			MIN	TYP	MAX	MIN	TYP	MAX	
V _{OUT}	Output Voltage	T _J = 25°C, V _{IN} = 7.5V, I _{OUT} = 0	4.9	5.0	5.1	4.9	5.0	5.1	V
		7.5V ≤ V _{IN} ≤ 15V 0 ≤ I _{OUT} ≤ 5A, P ≤ 30W ●	4.8		5.2	4.8		5.2	V
$\frac{\Delta V_{OUT}}{\Delta V_{IN}}$	Line Regulation	T _J = 25°C, 7.5V ≤ V _{IN} ≤ 15V (See Note 1)		5	15		5	15	mV
$\frac{\Delta V_{OUT}}{\Delta I_{OUT}}$	Load Regulation	T _J = 25°C, V _{IN} = 7.5V 0 ≤ I _{OUT} ≤ 5A (See Note 1)		25	100		25	100	mV
	Thermal Regulation	T _J = 25°C, 20 msec pulse		0.005	0.02		0.005	0.02	%/W
I _Q	Quiescent Current	7.5V ≤ V _{IN} ≤ 15V, 0 ≤ I _{OUT} ≤ 5A ●		12	20		12	20	mA
e _n	Output Noise Voltage	T _J = 25°C, 10Hz ≤ f ≤ 100kHz		40			40		μV _{rms}
I _{SC}	Short Circuit Current Limit	T _J = 25°C, V _{IN} = 15V V _{IN} = 7.5V		5	8		5	8	A
				7	9		7	9	A
	Long Term Stability of Output Voltage				35		35		mV
θ _{JC}	Thermal Resistance Junction to Case	K Package		1	1.5		1	1.5	°C/W

The ● denotes the specifications which apply over the full operating temperature range.

Note 1: Load and line regulation are tested with pulsed low duty cycle techniques where pulse width ≤ 1msec and duty cycle ≤ 5%.

Note 2: T_{min} = -55°C for the LT1003MK and 0°C for LT1003CK.
 T_{max} = 150°C for LT1003MK and 125°C for LT1003CK.

TYPICAL PERFORMANCE CHARACTERISTICS

Minimum Input-Output Voltage Differential

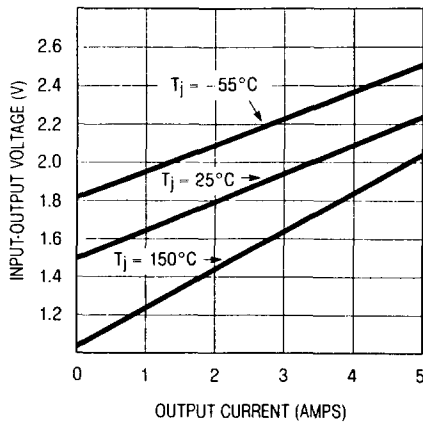

Output Voltage Temperature Drift

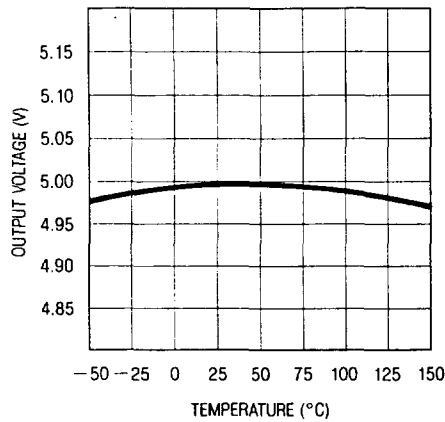

Peak Available Output Current

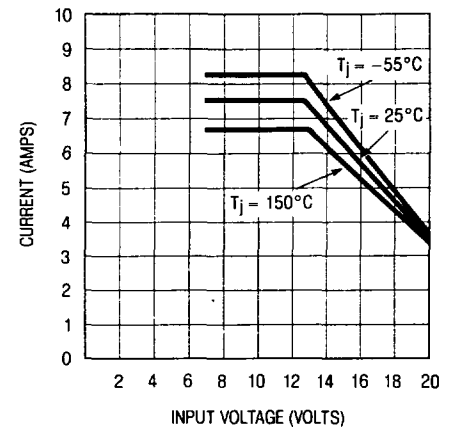

Output Impedance

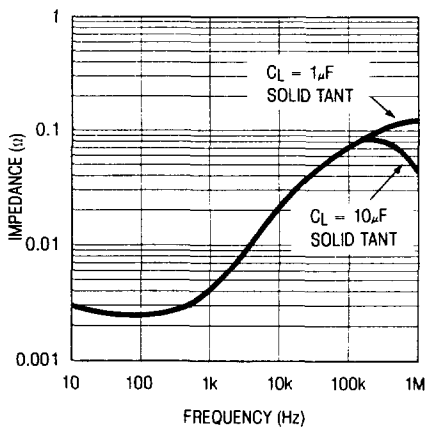

Suggested Heat Sink Thermal Resistance (LT1003C)

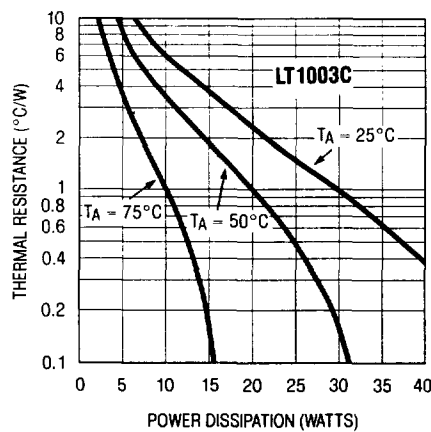

Suggested Heat Sink Thermal Resistance (LT1003M)

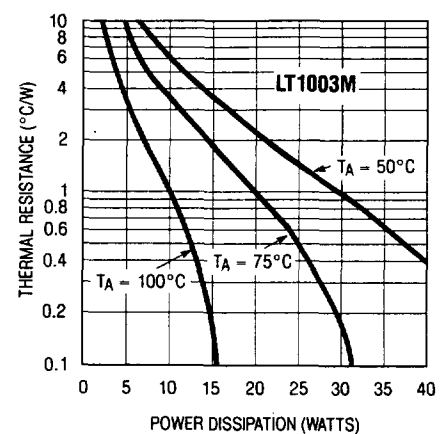

4

Output Noise Voltage

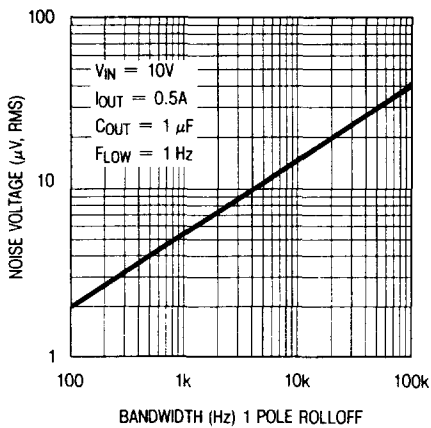

Ripple Rejection

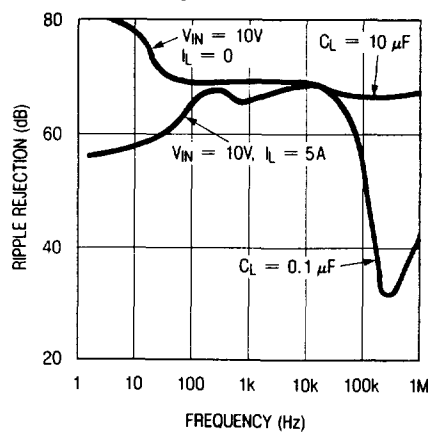

Line Transient Response

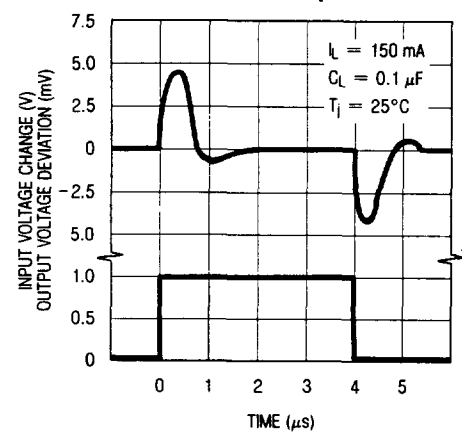

TYPICAL PERFORMANCE CHARACTERISTICS

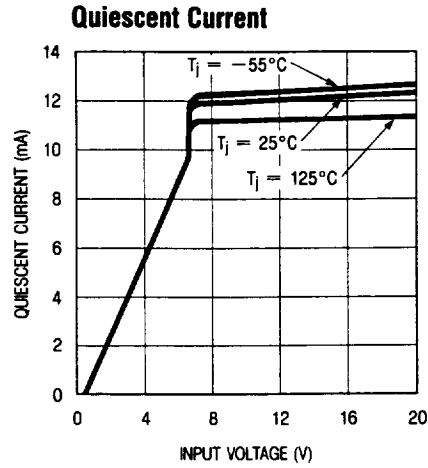
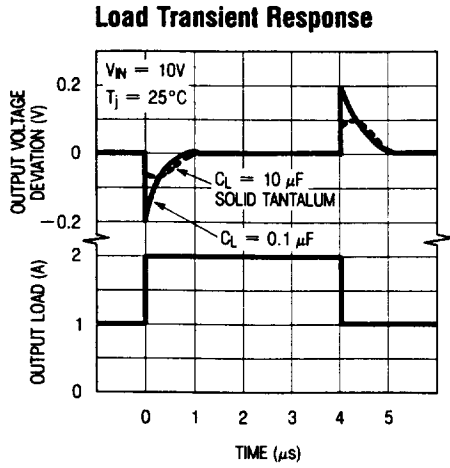

TYPICAL APPLICATIONS

Adjustable Regulator 0-10V @ 5A

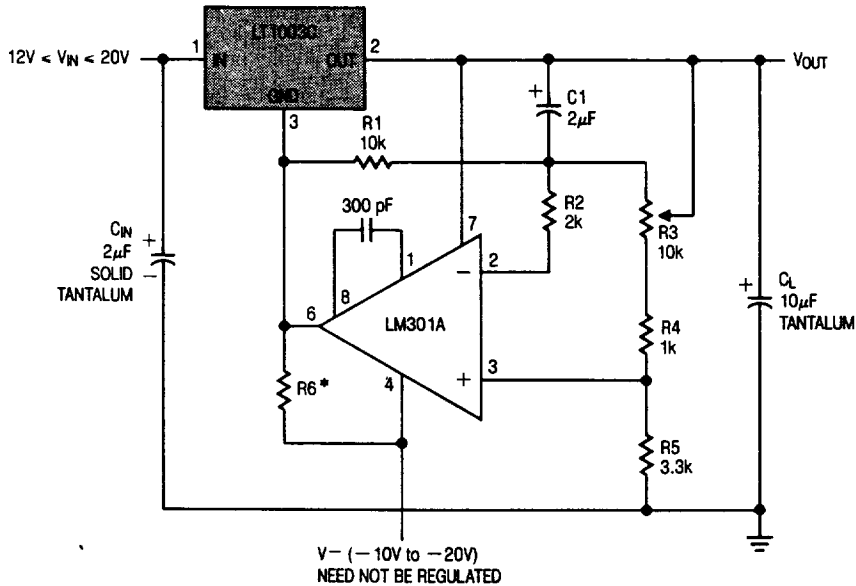

$$* R6 = \frac{V^-}{12 \text{ mA}}$$

C_1 = OPTIONAL — IMPROVES RIPPLE REJECTION, NOISE AND TRANSIENT RESPONSE

TYPICAL APPLICATIONS

Crowbar Protection††

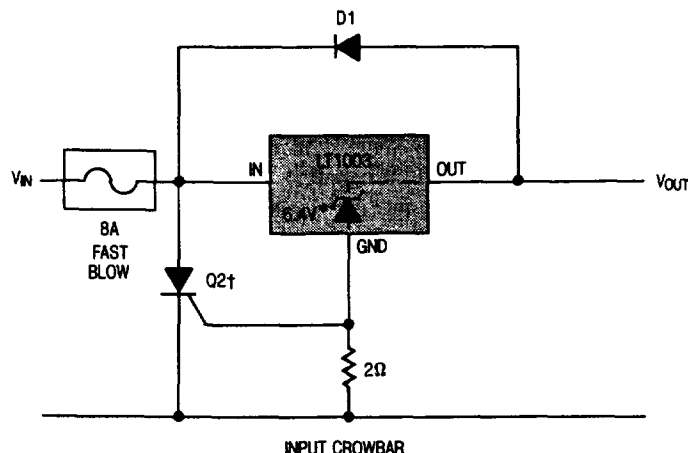
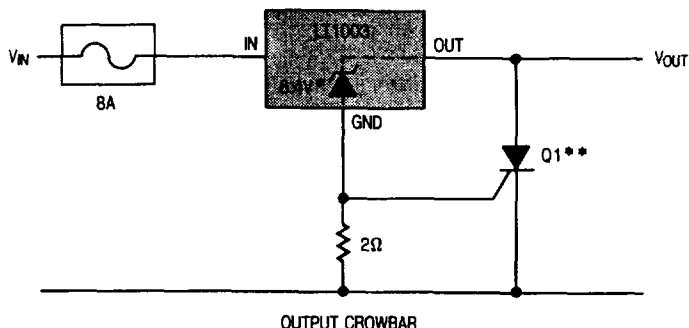

- * THE 6.4V ZENER IS INTERNAL TO THE LT1003.
- ** Q1 MUST BE ABLE TO WITHSTAND CONTINUOUS CURRENTS OF 8A IF ADDITIONAL SYSTEM SHUTDOWN IS NOT USED.

- † Q2 MUST WITHSTAND LARGE SURGE CURRENTS UNTIL THE 8A FUSE BLOWS. PEAK SURGE CURRENT IS LIMITED ONLY BY FUSE, WIRING, AND FILTER CAP RESISTANCE.

†† TRIP POINT IS APPROXIMATELY 7.3V.

4

Bypass Capacitors

The LT1003 does not require an output capacitor for resistive loads. For almost all applications, however, a 1 μ F or larger solid tantalum capacitor is used on the output within 2" of the regulator. This greatly improves the output impedance of the regulator at high frequencies. For critical applications where very low impedance is required at high frequencies, a 10 μ F solid tantalum output capacitor is recommended. Total output capacitance may be increased without limit, either local or distributed.

A 2 μ F or larger input capacitor (solid tantalum) must be added if the regulator is more than 4" away from the large filter capacitor in the input supply. A 25 μ F aluminum capacitor may be substituted for the tantalum unit.

Avoiding Ground Loops

For best regulation, the ground pin of the LT1003 should be tied directly to the load point as shown below. This prevents excess drop in load voltage caused by load current flowing through the ground return lead. This is essentially a Kelvin connection for the

low side of the regulator. A Kelvin connection cannot be made for the high output of the regulator because only three pins are available on the package. Therefore, every attempt should be made to minimize the resistance between the output pin of the regulator and the load. #18 gauge hookup wire has a resistance of 0.006 ohms per foot. This translates to 0.6% change in load voltage at full load current. The LT1003 is specified at 2% maximum load regulation, so one foot of wire represents a significant loss of regulation. If connectors are used, careful consideration must be given to contact resistance, especially if the connector is subjected to nasty ambients, vibration, or multiple insertions.

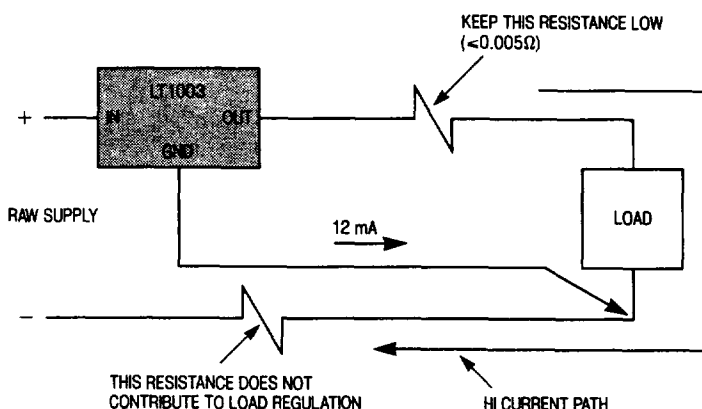

TYPICAL APPLICATIONS

Raw Supply

Transformer, diode, and capacitor selection for the raw supply to the LT1003 is very important because of the conflicting requirements for reliability, efficiency, and resistance to "brown-out" conditions. High secondary voltage on the transformer will cause unnecessarily high power dissipation in the regulator. Too low a secondary voltage will cause the regulator output to drop out of regulation with only a small reduction in AC mains voltage. The following formula gives a good starting point for transformer selection. This formula assumes a full-wave center tapped transformer, using two rectifier diodes.

$$V_{RMS} = \left(\frac{V_{OUT} + V_{DO} + V_{RECT} + V_{RIP}}{\sqrt{2}} \right) \left(\frac{V_{NOM}}{V_{LOW}} \right) \quad (1.1f)$$

(secondary
each side)

$$I_{RMS} = (I_{OUT}) \quad (1.2)$$

where:

$$V_{OUT} = 5V$$

$$V_{DO} = \text{Minimum input-output differential of the regulator}$$

*1.1 is a nominal load regulation factor for the transformer

$$V_{RECT} = \text{Rectifier forward drop at } 3I_{OUT}$$

$$V_{RIP} = \frac{1}{2} \text{ p-p capacitor ripple voltage}$$

$$V_{RIP} \approx \frac{(5.3 \times 10^{-3})(I_{OUT})}{2C}$$

$$V_{NOM} = \text{Rated line voltage for the transformer (RMS)}$$

$$V_{LOW} = \text{Lowest expected line voltage (RMS)}$$

$$I_{OUT} = \text{DC output current}$$

$$\text{Example: } I_{OUT} = 4A, V_{OUT} = 5V$$

$$\text{Assume: } V_{DO} = 2.5V, V_{RECT} = 1.1V, C = 12,000\mu F$$

$$V_{NOM} = 115V, V_{LOW} = 105V$$

$$V_{RIP} = \frac{(5.3 \times 10^{-3})(4)}{2(12 \times 10^{-3})} = 0.88V$$

$$V_{RMS} = \left(\frac{5 + 2.5 + 1.1 + 0.88}{\sqrt{2}} \right) \left(\frac{115}{105} \right) \quad (1.1)$$

$$= 8.08 V_{RMS}$$

The filter capacitor should be at *least* 2000 μ F per amp of load current to minimize capacitor heating and ripple voltage. The diodes should be rated at 8–10 amps even though their average current is only 2.5A at full rated load current. The reason for this is that although the *average* current is 2.5A, the RMS current is typically twice this value. In addition, the diode must withstand very high surge currents during power turn-on. This surge can be 10–20 times the DC rating of the supply, depending on capacitor size and wiring resistance and inductance.

SCHEMATIC DIAGRAM

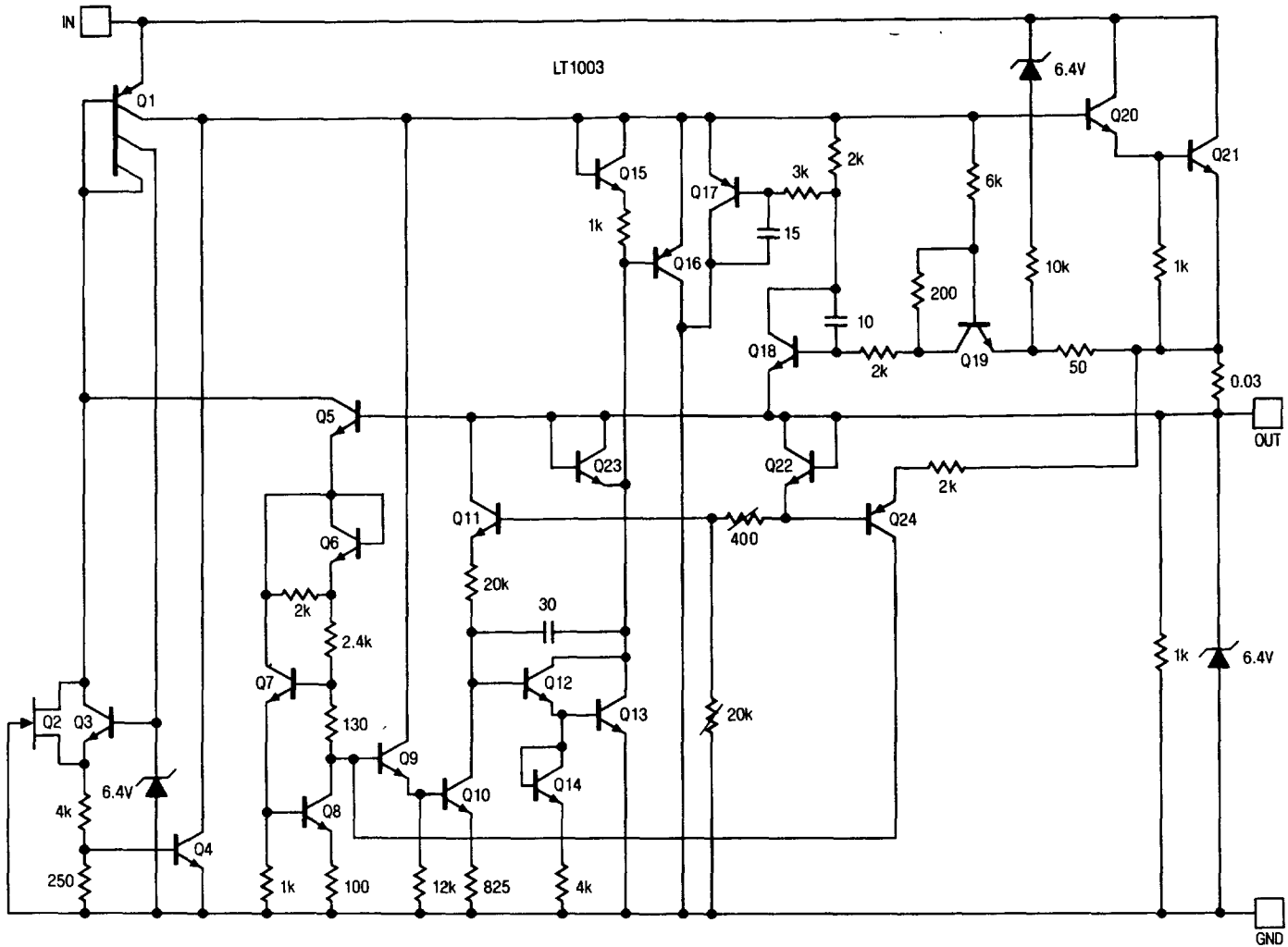

4

PACKAGE DESCRIPTION Dimensions in inches (millimeters) unless otherwise noted.

K Package TO-3 STEEL Metal Can

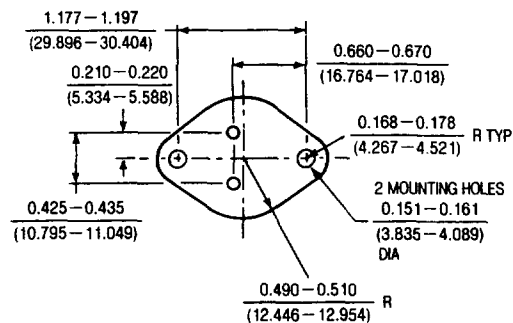
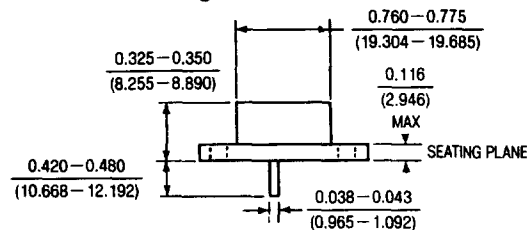

	T _j max.	θ _{ja}	θ _{jc}
LT1003MK	150°C	35°C/W	1.5°C/W
LT1003CK	125°C	35°C/W	1.5°C/W