

## Optocoupler, Phototransistor Output, AC Input, With Base Connection

### Features

- AC or Polarity Insensitive Input
- Built-in Reverse Polarity Input Protection
- Improved CTR Symmetry
- Industry Standard DIP Package

### Agency Approvals

- UL File #E52744 System Code H or J
- CSA 93751
- BSI IEC60950 IEC60965
  
- DIN EN 60747-5-2(VDE0884)  
DIN EN 60747-5-5 pending  
Available with Option 1

### Applications

Ideal for AC signal detection and monitoring.

### Description

The IL250/ 251/ 252/ ILD250/ 251/ 252 are bidirectional input optically coupled isolators consisting of two Gallium Arsenide infrared LEDs coupled to a silicon NPN phototransistor per channel.

The IL250/ ILD/250 has a minimum CTR of 50 %, the IL251/ ILD251 has a minimum CTR of 20 %, and the IL252/ ILD252 has a minimum CTR of 100 %. The IL250/ IL251/ IL252 are single channel optocouplers. The ILD250/ ILD251/ ILD252 has two isolated channels in a single DIP package.

Single Channel

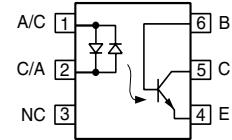
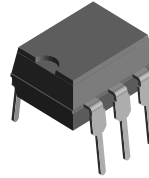

Dual Channel

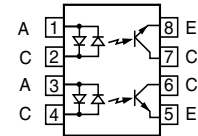
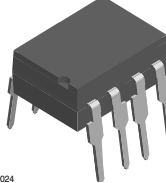

i179024

### Order Information

Part	Remarks
IL250	CTR > 50 %, Single Channel DIP-6
IL251	CTR > 20 %, Single Channel DIP-6
IL252	CTR > 100 %, Single Channel DIP-6
ILD250	CTR > 50 %, Dual Channel DIP-8
ILD251	CTR > 20 %, Dual Channel DIP-8
ILD252	CTR > 100 %, Dual Channel DIP-8
IL250-X007	CTR > 50 %, Single Channel SMD-6 (option 7)
IL250-X009	CTR > 50 %, Single Channel SMD-6 (option 9)
IL251-X009	CTR > 20 %, Single Channel SMD-6 (option 9)
IL252-X007	CTR > 100 %, Single Channel SMD-6 (option 7)
IL252-X009	CTR > 100 %, Single Channel SMD-6 (option 9)
ILD250-X009	CTR > 50 %, Dual Channel SMD-6 (option 9)
ILD251-X006	CTR > 20 %, Dual Channel DIP-8 400 mil (option 6)
ILD251-X007	CTR > 20 %, Dual Channel SMD-6 (option 7)
ILD251-X009	CTR > 20 %, Dual Channel SMD-6 (option 9)
ILD252-X009	CTR > 100 %, Dual Channel SMD-6 (option 9)

For additional information on the available options refer to Option Information.

### Absolute Maximum Ratings

$T_{amb} = 25\text{ °C}$ , unless otherwise specified

Stresses in excess of the absolute Maximum Ratings can cause permanent damage to the device. Functional operation of the device is not implied at these or any other conditions in excess of those given in the operational sections of this document. Exposure to absolute Maximum Rating for extended periods of the time can adversely affect reliability.

### Input

Parameter	Test condition	Symbol	Value	Unit
Forward continuous current		$I_F$	60	mA
Power dissipation		$P_{diss}$	100	mW
Derate linearly from 25 °C			1.33	mW/°C

### Output

Parameter	Test condition	Symbol	Value	Unit
Collector-emitter breakdown voltage		$BV_{CEO}$	30	V
Emitter-base breakdown voltage		$BV_{EBO}$	5.0	V
Collector-base breakdown voltage		$BV_{CBO}$	70	V
Power dissipation single channel		$P_{diss}$	200	mW
Power dissipation dual channel		$P_{diss}$	150	mW
Derate linearly from 25 °C single channel			2.6	mW/°C
Derate linearly from 25 °C dual channel			2.0	mW/°C

### Coupler

Parameter	Test condition	Symbol	Value	Unit
Isolation test voltage (between emitter and detector referred to standard climate 23 °C/50 %RH, DIN 50014)		$V_{ISO}$	5300	$V_{RMS}$
Creepage			≥ 7.0	mm
Clearance			≥ 7.0	mm
Isolation resistance	$V_{IO} = 500\text{ V}, T_{amb} = 25\text{ °C}$	$R_{IO}$	$10^{12}$	$\Omega$
	$V_{IO} = 500\text{ V}, T_{amb} = 100\text{ °C}$	$R_{IO}$	$10^{11}$	$\Omega$
Total dissipation single channel		$P_{tot}$	250	mW
Total dissipation dual channel		$P_{tot}$	400	mW
Derate linearly from 25 °C single channel			3.3	mW/°C
Derate linearly from 25 °C dual channel			5.3	mW/°C
Storage temperature		$T_{stg}$	- 55 to + 150	°C
Operating temperature		$T_{amb}$	- 55 to + 100	°C
Lead soldering time at 260 °C			10	sec.

## Electrical Characteristics

$T_{amb} = 25\text{ }^{\circ}\text{C}$ , unless otherwise specified

Minimum and maximum values are testing requirements. Typical values are characteristics of the device and are the result of engineering evaluation. Typical values are for information only and are not part of the testing requirements.

### Input

Parameter	Test condition	Symbol	Min	Typ.	Max	Unit
Forward voltage	$I_F = \pm 10\text{ mA}$	$V_F$		1.2	1.5	V

### Output

Parameter	Test condition	Symbol	Min	Typ.	Max	Unit
Collector-emitter breakdown voltage	$I_C = 1.0\text{ mA}$	$BV_{CEO}$	30	50		V
Emitter-base breakdown voltage	$I_E = 100\text{ }\mu\text{A}$	$BV_{EBO}$	7.0	10		V
Collector-base breakdown voltage	$I_C = 10\text{ }\mu\text{A}$	$BV_{CBO}$	70	90		V
Collector-emitter leakage current	$V_{CE} = 10\text{ V}$	$I_{CEO}$		5.0	50	nA

### Coupler

Parameter	Test condition	Symbol	Min	Typ.	Max	Unit
Collector-emitter saturation voltage	$I_F = \pm 16\text{ mA}$ , $I_C = 2.0\text{ mA}$	$V_{CEsat}$			0.4	V

### Current Transfer Ratio

Parameter	Test condition	Part	Symbol	Min	Typ.	Max	Unit
DC Current Transfer Ratio	$I_F = \pm 10\text{ mA}$ , $V_{CE} = 10\text{ V}$	ILD250	$CTR_{DC}$	50			%
		ILD251	$CTR_{DC}$	20			%
		ILD252	$CTR_{DC}$	100			%
Symmetry (CTR @ +10 mA)/ (CTR @ -10 mA)				0.50	1.0	2.0	

### Typical Characteristics ( $T_{amb} = 25\text{ }^{\circ}\text{C}$ unless otherwise specified)

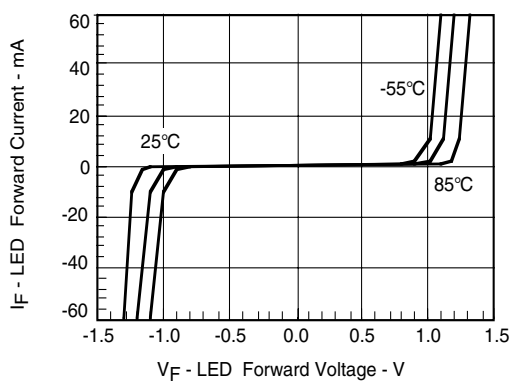

00250\_01

Fig. 1 LED Forward Current vs. Forward Voltage

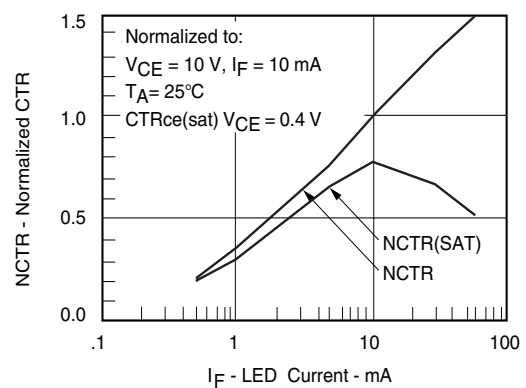

00250\_02

Fig. 2 Normalized Non-Saturated and Saturated CTR vs. LED Current

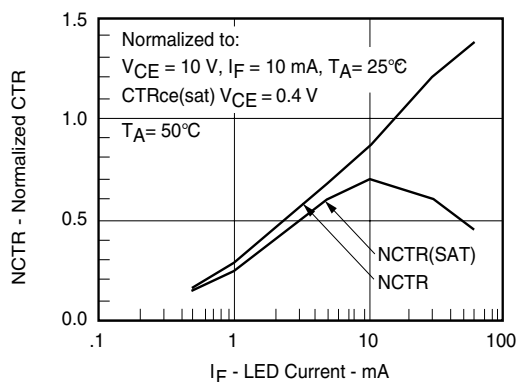

250\_03

Fig. 3 Normalized Non-saturated and Saturated CTR vs. LED Current

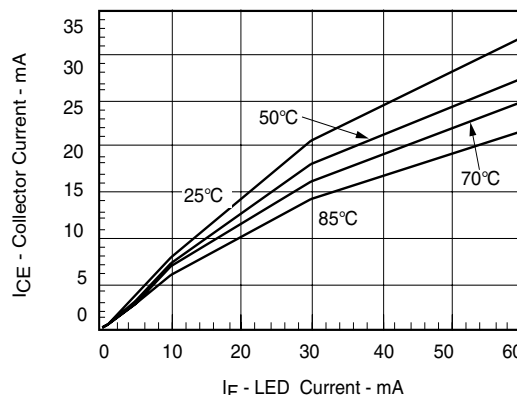

250\_06

Fig. 6 Collector-Emitter Current vs. Temperature and LED Current

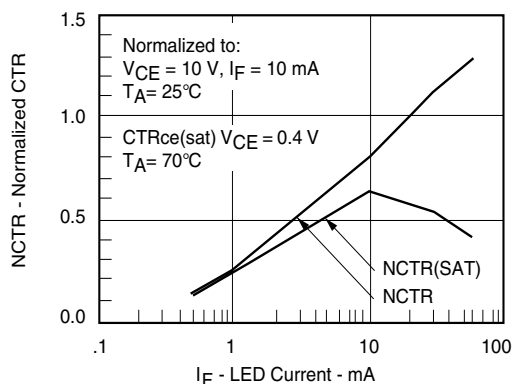

250\_04

Fig. 4 Normalized Non-saturated and saturated CTR vs. LED Current

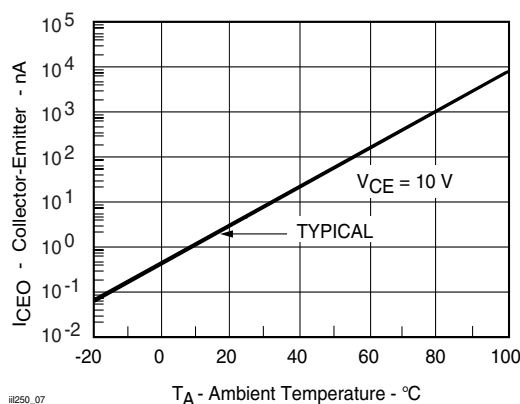

250\_07

Fig. 7 Collector-Emitter Leakage Current vs. Temp.

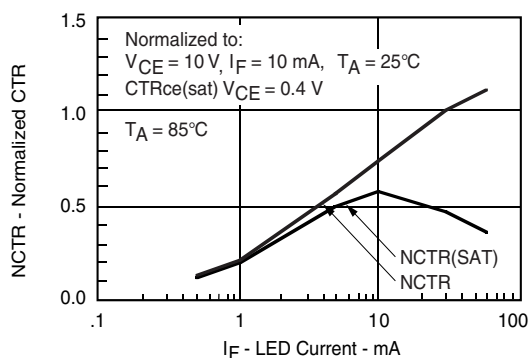

250\_05

Fig. 5 Normalized Non-saturated and saturated CTR vs. LED Current

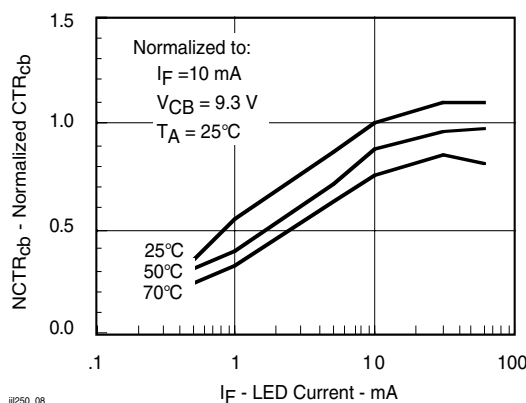

250\_08

Fig. 8 Normalized  $CTR_{cb}$  vs. LED Current and Temperature

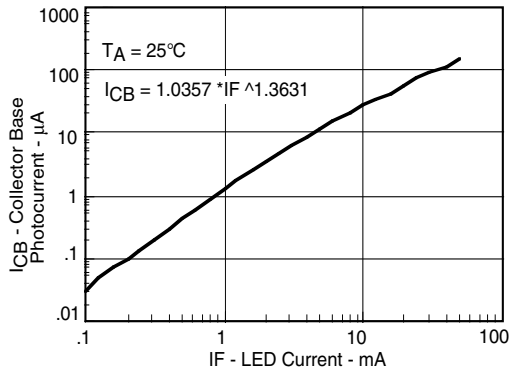

ii250\_09

Fig. 9 Collector-Base Photocurrent vs. LED Current

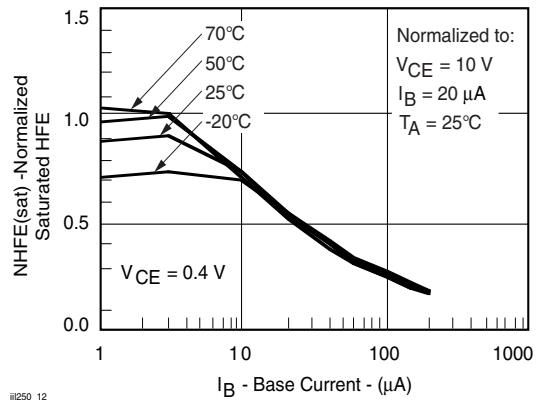

ii250\_12

Fig. 12 Normalized Saturated HFE vs. Base Current and Temperature

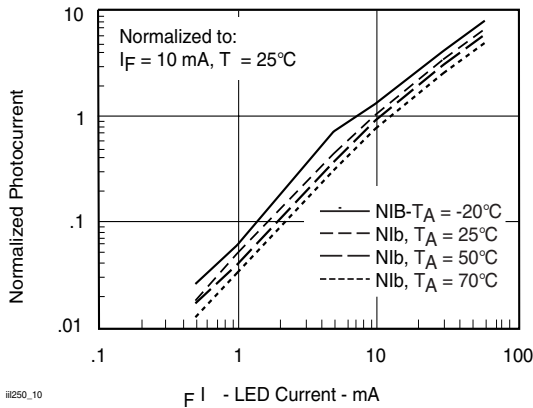

ii250\_10

Fig. 10 Normalized Photocurrent vs.  $I_F$  and Temp.

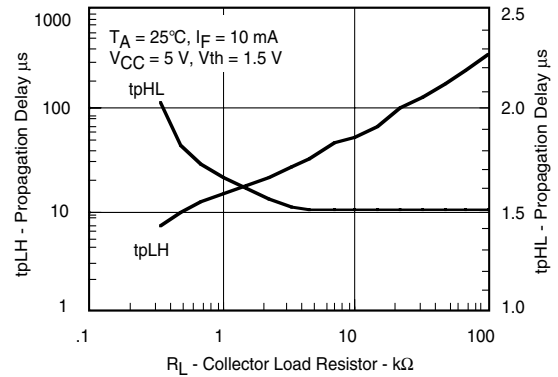

ii250\_13

Fig. 13 Propagation Delay vs. Collector Load Resistor

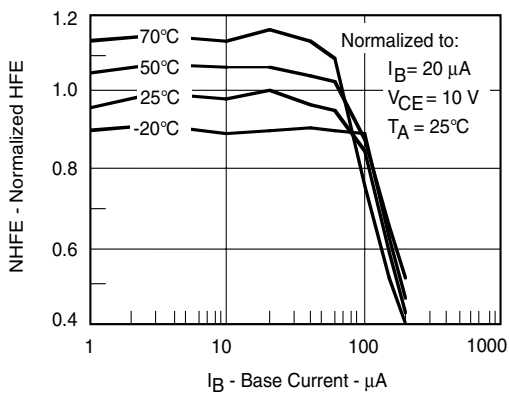

ii250\_11

Fig. 11 Normalized Non-saturated HFE vs. Base Current and Temperature

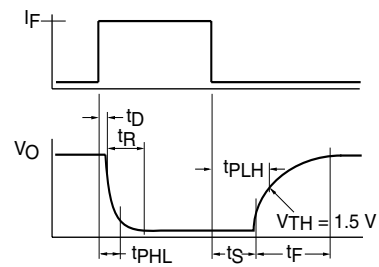

ii250\_14

Fig. 14 Switching Timing

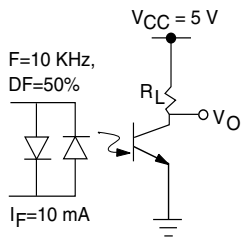

il250\_15

Fig. 15 Switching Schematic

## Package Dimensions in Inches (mm)

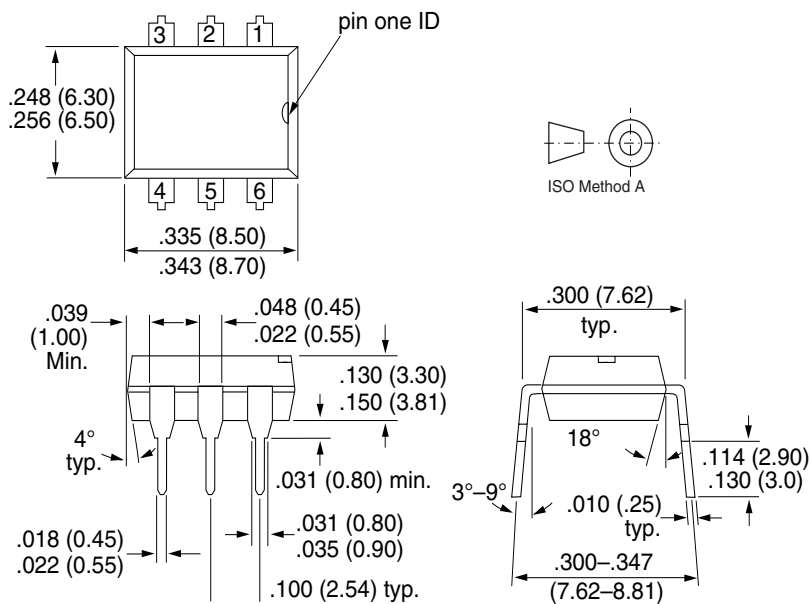

i178004



## Package Dimensions in Inches (mm)

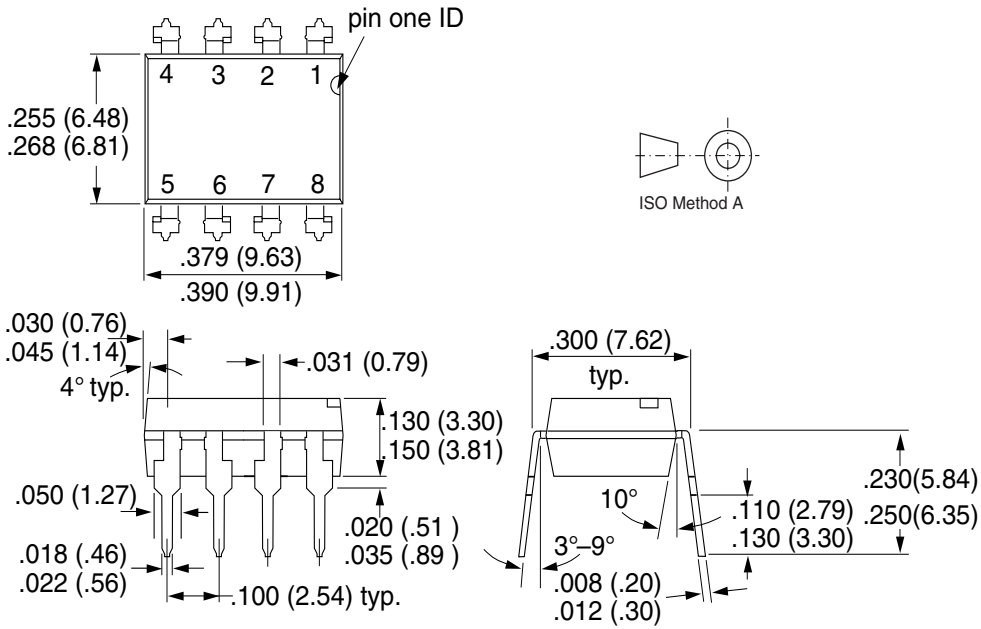

i178006

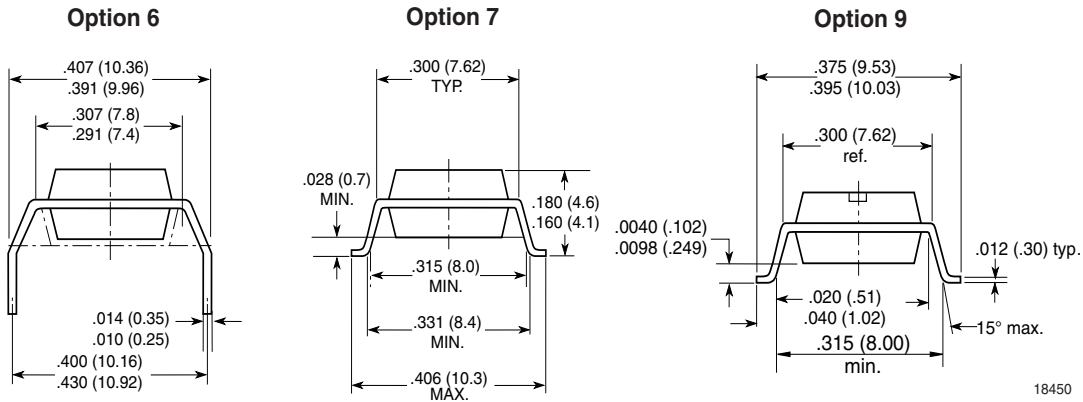

18450

### Ozone Depleting Substances Policy Statement

It is the policy of **Vishay Semiconductor GmbH** to

1. Meet all present and future national and international statutory requirements.
2. Regularly and continuously improve the performance of our products, processes, distribution and operating systems with respect to their impact on the health and safety of our employees and the public, as well as their impact on the environment.

It is particular concern to control or eliminate releases of those substances into the atmosphere which are known as ozone depleting substances (ODSs).

The Montreal Protocol (1987) and its London Amendments (1990) intend to severely restrict the use of ODSs and forbid their use within the next ten years. Various national and international initiatives are pressing for an earlier ban on these substances.

**Vishay Semiconductor GmbH** has been able to use its policy of continuous improvements to eliminate the use of ODSs listed in the following documents.

1. Annex A, B and list of transitional substances of the Montreal Protocol and the London Amendments respectively
2. Class I and II ozone depleting substances in the Clean Air Act Amendments of 1990 by the Environmental Protection Agency (EPA) in the USA
3. Council Decision 88/540/EEC and 91/690/EEC Annex A, B and C (transitional substances) respectively.

**Vishay Semiconductor GmbH** can certify that our semiconductors are not manufactured with ozone depleting substances and do not contain such substances.

**We reserve the right to make changes to improve technical design  
and may do so without further notice.**

Parameters can vary in different applications. All operating parameters must be validated for each customer application by the customer. Should the buyer use Vishay Semiconductors products for any unintended or unauthorized application, the buyer shall indemnify Vishay Semiconductors against all claims, costs, damages, and expenses, arising out of, directly or indirectly, any claim of personal damage, injury or death associated with such unintended or unauthorized use.

Vishay Semiconductor GmbH, P.O.B. 3535, D-74025 Heilbronn, Germany  
Telephone: 49 (0)7131 67 2831, Fax number: 49 (0)7131 67 2423